



# SWING SLIDE CLIMB

Customer Support: (03) 9786 0055

## Toddler play set

Thank you for purchasing Toddler play set  
Warning: Only for domestic outdoor use.

This Play Set satisfies all the requirements of the Australian Standard AS/NZS ISO 8124 and has been certified by an independent laboratory. To guarantee safety, please give special attention to the assembly, safety, and care instructions detailed in this document.

### ASSEMBLY ADVICE

- Follow the instructions exactly.
  - This product must be assembled by adults.
  - Once assembly has been completed, keep the instructions in a safe place for future reference. This can be particularly handy for identification of parts if any after sales service is required.
  - Before commencing assembly, check that none of the parts are missing. If you find that you are missing a part please contact our after sales service department.
  - Retain extra parts to use as spares in the future if necessary.
  - Pre-Drill timber before fixing with screws to avoid cracks in the timber.
- The dimensions given in the instructions are indicative only, they may vary according to the assembly method.

### SAFETY ADVICE

- As per legal requirements, it must have a 20cm minimal distance between the ground and the baby seat. This distance is important for safety. The distance between the swing seat and the ground can be adjusted using the adjustable plastic hook.
- Warning. This product is only to be used by children between the ages of 6 and 84 months. BUT THE AGE LIMIT FOR BABY SWING SEAT IS 6 TO 24 MONTHS.
- Warning. For baby seat it cannot be used by anyone weighing over 25kgs; Other parts not exceed 35kg, simultaneously, not to exceed a combined weight of 150 kgs
- Warning: Choking hazard-small parts can be dangerous for children .
- Warning: It must be used under adult supervision.
- This product is for private use at home only. Under no circumstances is it to be used in parks, schools, camp sites, hotels, public leisure areas etc.
- The swing set should be set up on a flat surface and 2 metres away from any structures or obstacles (walls, fences, trees, washing lines, cables etc).
- To avoid eye damage, we advise that the swing should not be setup directly facing the sun.
- The swing set should be installed over impact absorbing surfaces such as sand, wood-bark chips, rubber and foam and must NOT be set up on a hard surface (concrete, tarmac etc).detail surfacing materials please refer attached consumer information sheet.
- We recommend to secure your swing set firmly into the ground using cement.
- The anchorage must be checked regularly.
- Dispose of packaging thoughtfully.
- Do not allow children to play with packaging.
- **Maximum fall height for swing set please refer below graphic**

**CAUTION !** This Product includes timber and/or fabric, Please Keep away from fire.

### FIXING INTO THE GROUND

**IMPORTANT !** For safety reasons, your play set must be embedded into the ground.

- Place your play set in the desired position and mark a square area 300mm x 300 mm around each of the feet. Dig holes 300 mm deep. (The feet must be in the center of the square)
- Fill the holes with concrete. Do not exceed the ground level. Fit the embedding piece into the center of the concrete so that fixtures for screwing the posts into place rise out of the concrete.
- When the concrete is dry, screw the posts to the embedding pieces.
- Anchors shall be placed level with or under ground in order to reduce tripping hazards.

**IMPORTANT !** Wait until the concrete is set before using and check anchorages regularly.

### MAINTENANCE

- All parts should be checked at least once a month.
- Check all nuts and bolts for tightness and tighten when required.
- Check for signs of wear to bolt coverings. If sharp edges are found, replace as required.
- In certain regions (seaside areas), certain coatings could be prone to damage. In this case, it is advised to use a rust prevention treatment.
- Check swing seats, chains, ropes and other means of attachment for evidence of deterioration; replace when required in accordance with the manufacturer's instructions.



- All parts that are under constant friction should be oiled regularly using a suitable lubricant.
- The ground on which the play centre is set up should be cleared regularly. All objects such as stones or anything else that could cause injury in the case of a fall should be removed.
- It is recommended that during the winter period when the equipment is not in use, all apparatus are removed to prevent deterioration due to bad weather.
- Sand rusted areas and tubular members and repaint using a non-lead based paint when required
- Modifications to the original activity toy should only be carried out under instructions from the manufacturer.
- Defective parts should only be replaced in accordance with the manufacturer's instructions.
- For aesthetic reasons, you may want to apply a timber treatment to the timber parts.



All outdoor wooden products require routine inspection and regular maintenance. After installation, a follow-up inspection should take place after one week and twice a month thereafter for the remaining life of your play products. Maintenance should be performed at any time it is deemed necessary. As a general rule, major maintenance (wood refinishing) should be performed at twelve month intervals from the date of installation. Inspect and perform maintenance based on the following checklist.

Major wooden parts: Inspect for splintering and structure defects at regular intervals. For very minor splinters or chipping, lightly sanding and refinish with an exterior water repellent stain can assist. If timber has cracked or split significantly, replacement parts may be required, please contact national customer service centre for any replacement requirements

At regular intervals, the application of a penetrating oil based sealer stain to all wooden components is essential. Please consult your local hardware or home improvement store for recommendation of an appropriate product. Ensure the product does not contain hazardous chemicals once dry that can pose a potential health risk to children.

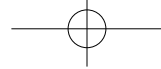

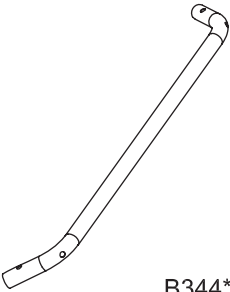
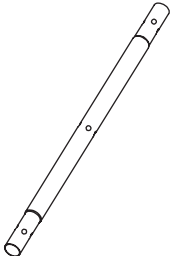
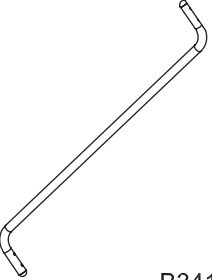
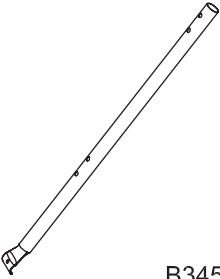
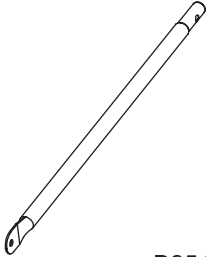
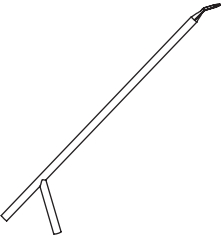
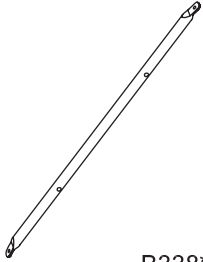
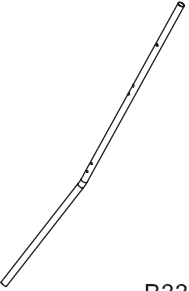
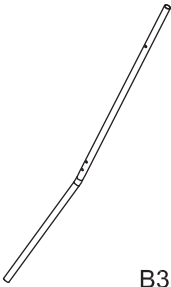
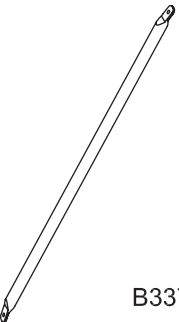
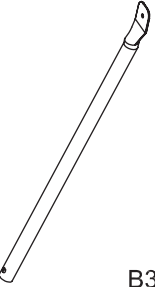
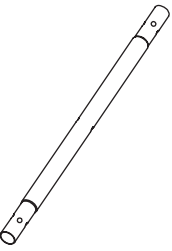
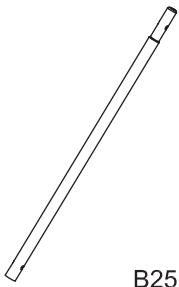
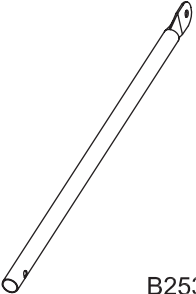
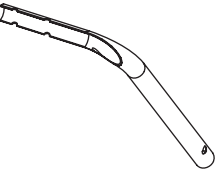
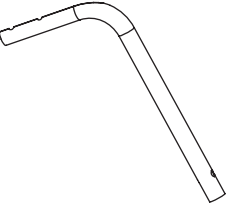
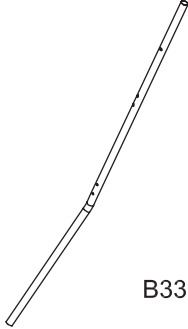
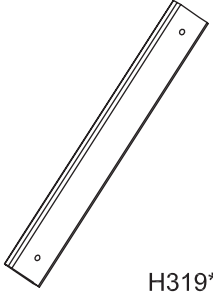
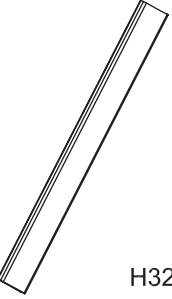
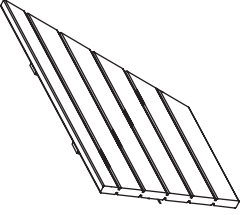
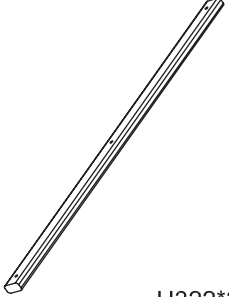
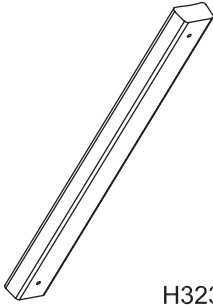

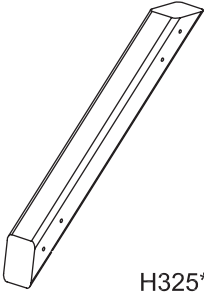
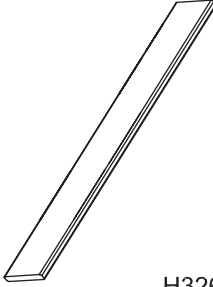
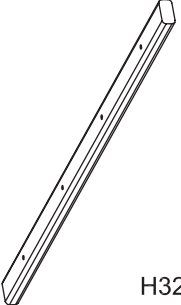
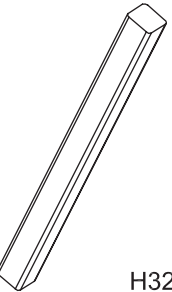
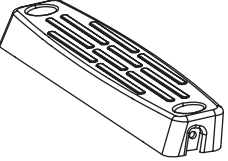
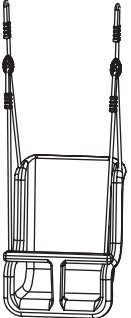
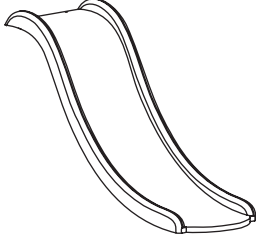
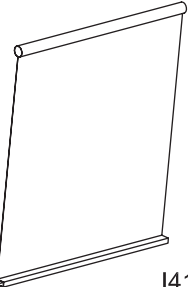
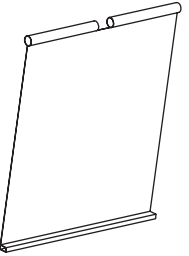

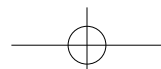

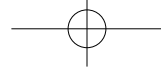

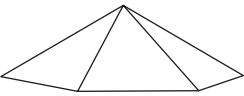
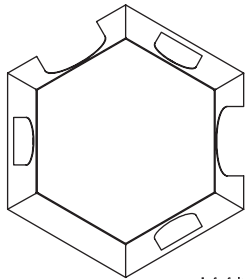
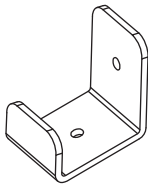
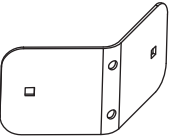

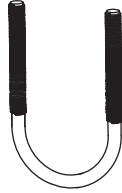







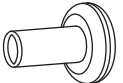
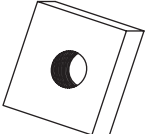

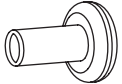
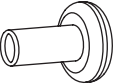



We hope you have a safe and enjoyable time using the Toddler Play Set.



 B344*3	 B342*1	 B341*2	 B345*1	 B254*1	 B340*6	 B338*1	 B335*1
 B334*4	 B337*5	 B339*2	 B343*2	 B251*4	 B253*1	 B250*1	 B249*1
 B336*1	 H319*6	 H320*1	 H321*2	 H322*3	 H323*1	 H324*2	 H325*2
 H326*4	 H327*4	 H328*1	 C27*1	 BB*1	 C17*1	 I41*2	 I42*1





 I43*1	 I44*1	 D61*2	 D60*6	 D59*4	 D56*2	 D2*4	 D15*6
$\text{Ø}6*20$  F10*10	$\text{Ø}6*40$  E12*14	$\text{Ø}6*30$  E15*2	$\text{Ø}6*13$  E19*3	$\text{Ø}6*25$  E28*31	$\text{Ø}4*15$  N30*1	$\text{Ø}6*12$  G5*28	$\text{Ø}6$  G6*2
$\text{Ø}6$  G16*4	$\text{Ø}6*20$  G13*28	$\text{Ø}4*12$  G4*1	$\text{Ø}5*25$  J3*11	$\text{Ø}4.5*20$  J8*26	$\text{Ø}4.5*35$  J10*14	$\text{Ø}4.5*30$  J12*16	$\text{Ø}5*50$  J13*8
$\text{Ø}6*50$  J11*6	$\text{Ø}6*40$  J18*2	$\text{Ø}8$  L1*18	$\text{Ø}6$  L2*45	$\text{Ø}6$  D10*66	$\text{Ø}8$  D35*18	A=4  A4*2	M6(10)  M6(10)*1

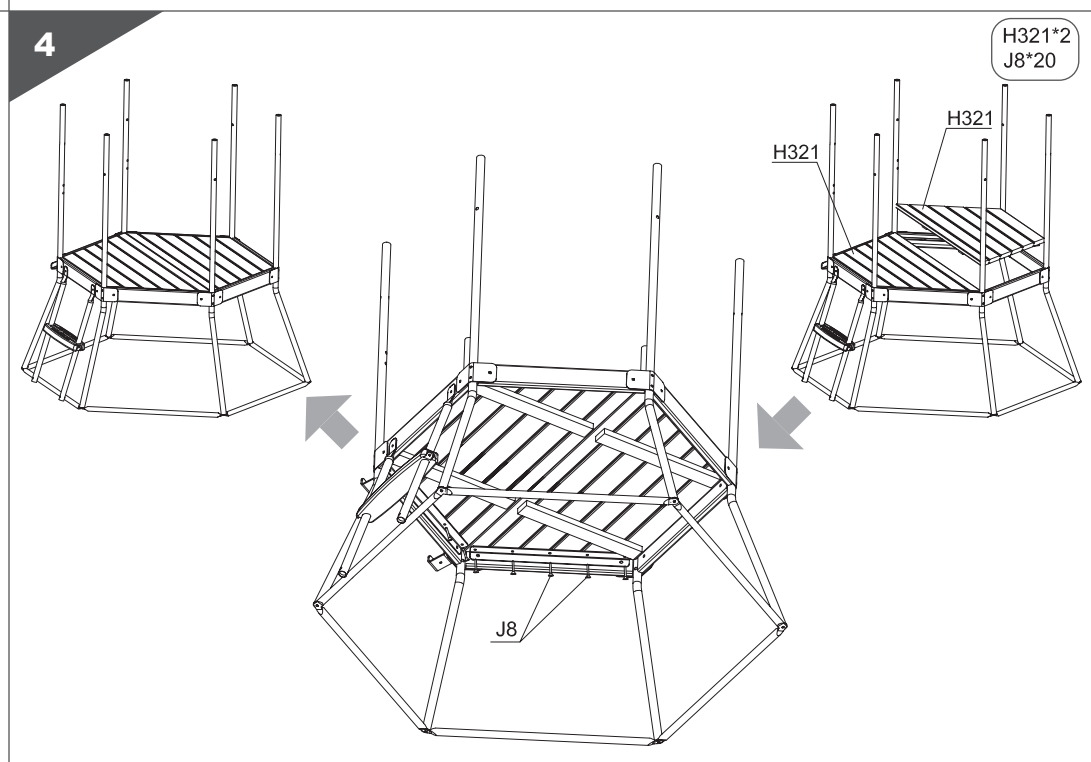
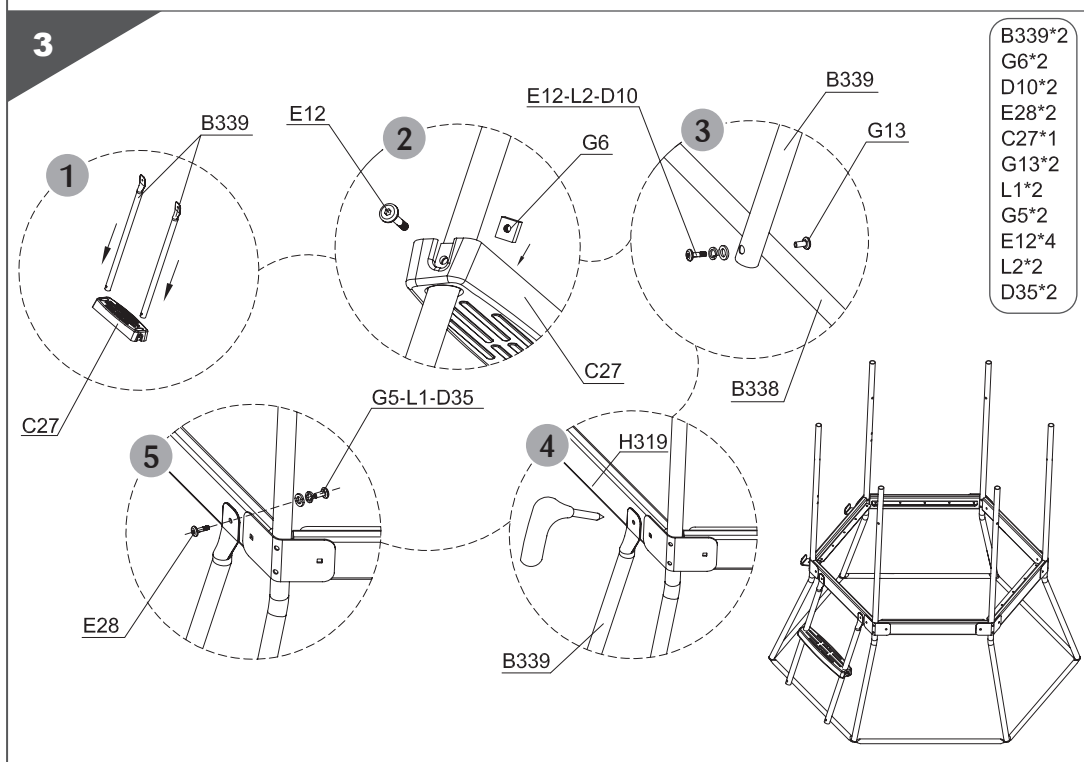
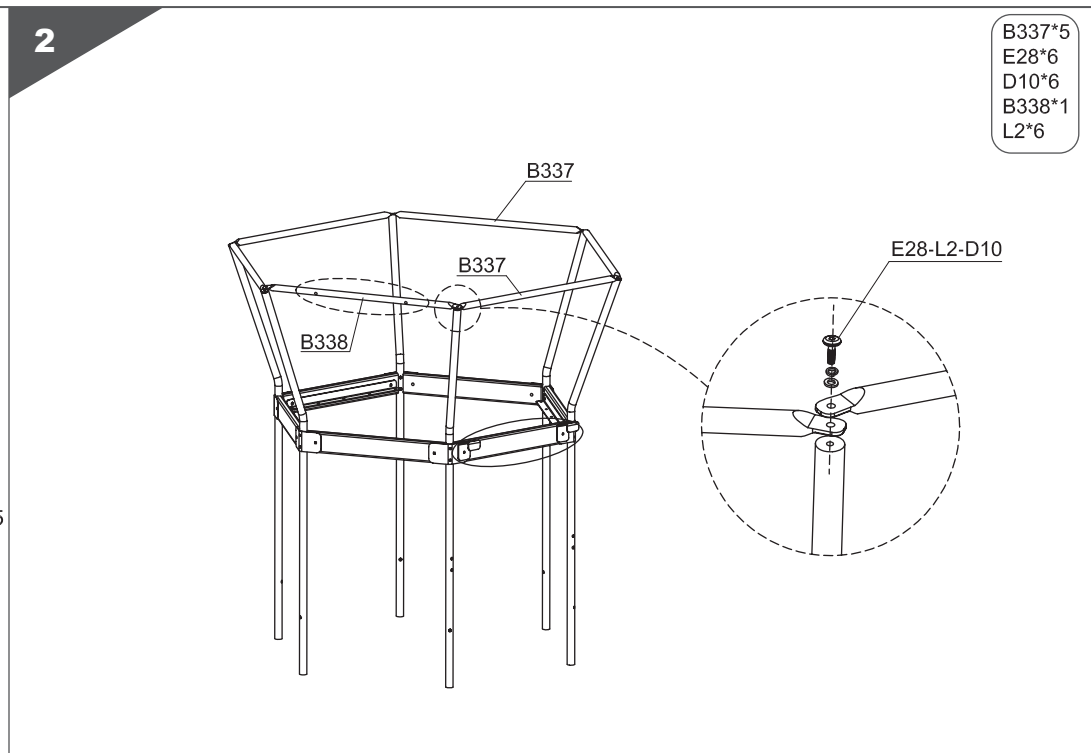
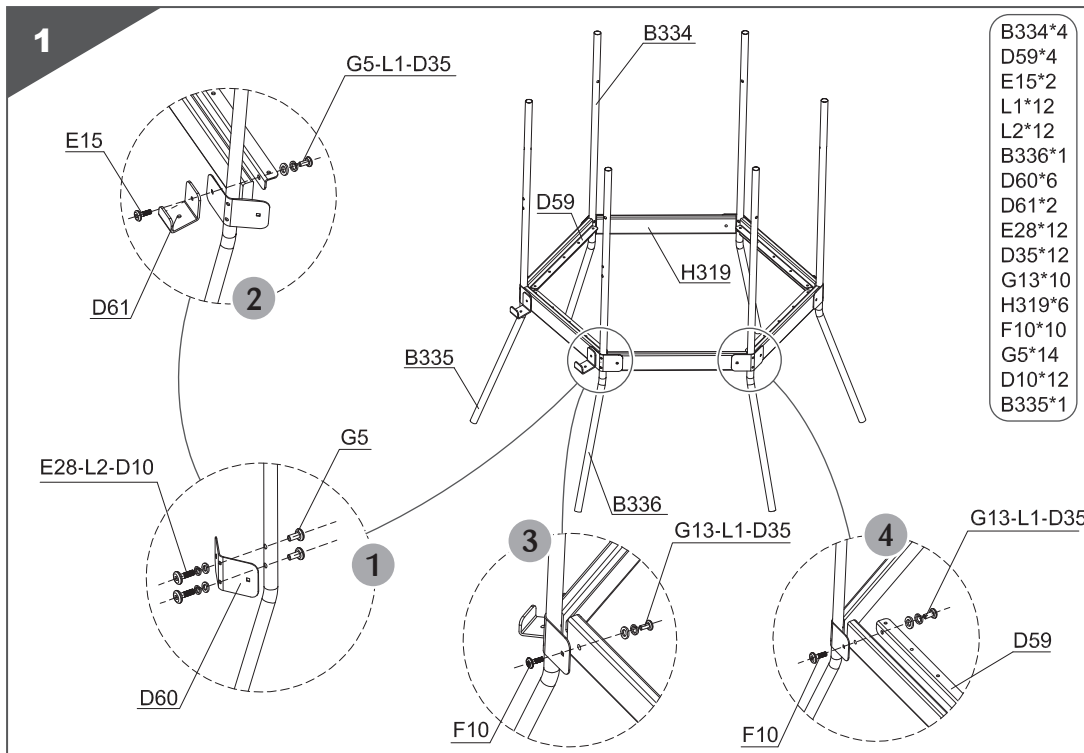

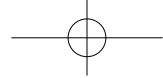

5

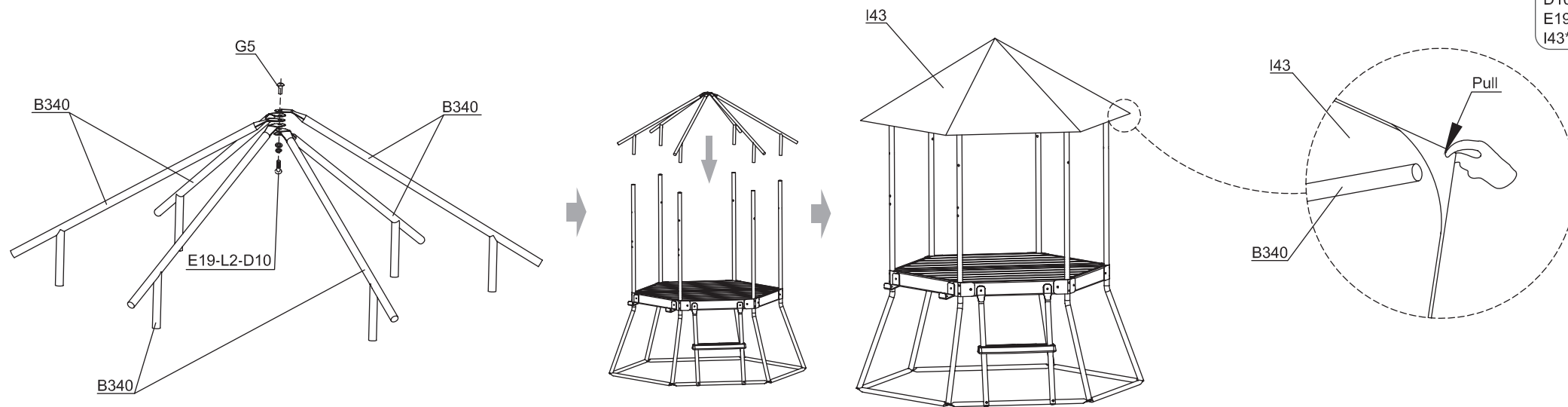

- B340\*6
- L2\*1
- G5\*1
- D10\*1
- E19\*1
- I43\*1

6

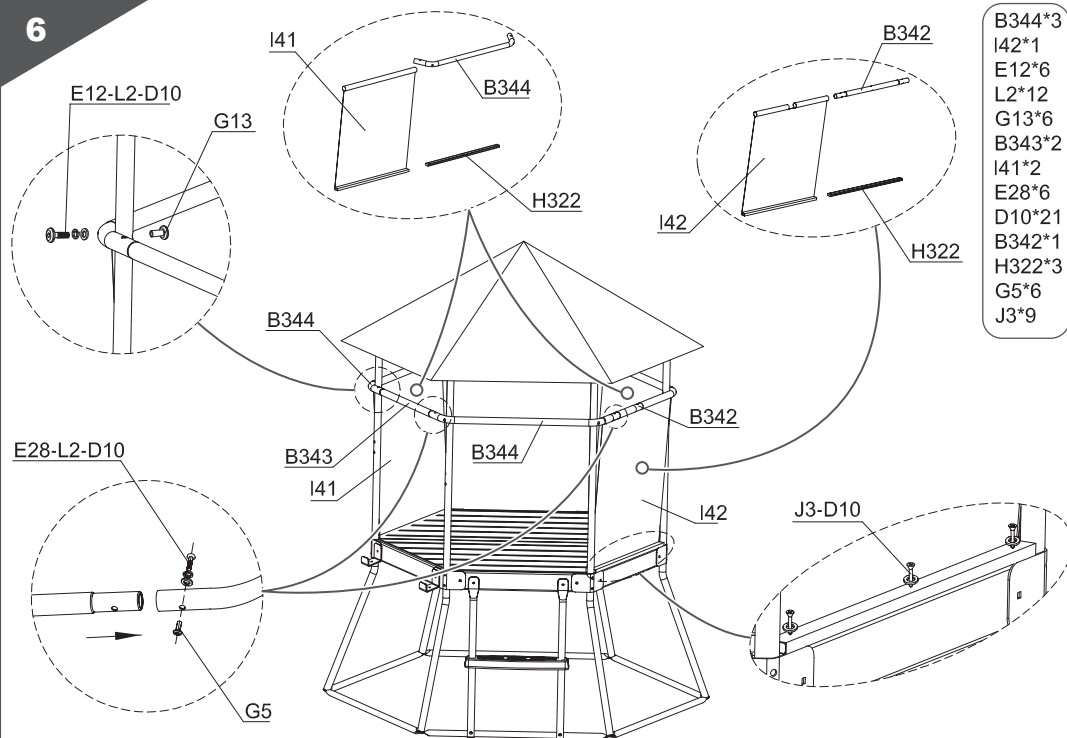

- B344\*3
- I42\*1
- E12\*6
- L2\*12
- G13\*6
- B343\*2
- I41\*2
- E28\*6
- D10\*21
- B342\*1
- H322\*3
- G5\*6
- J3\*9

7

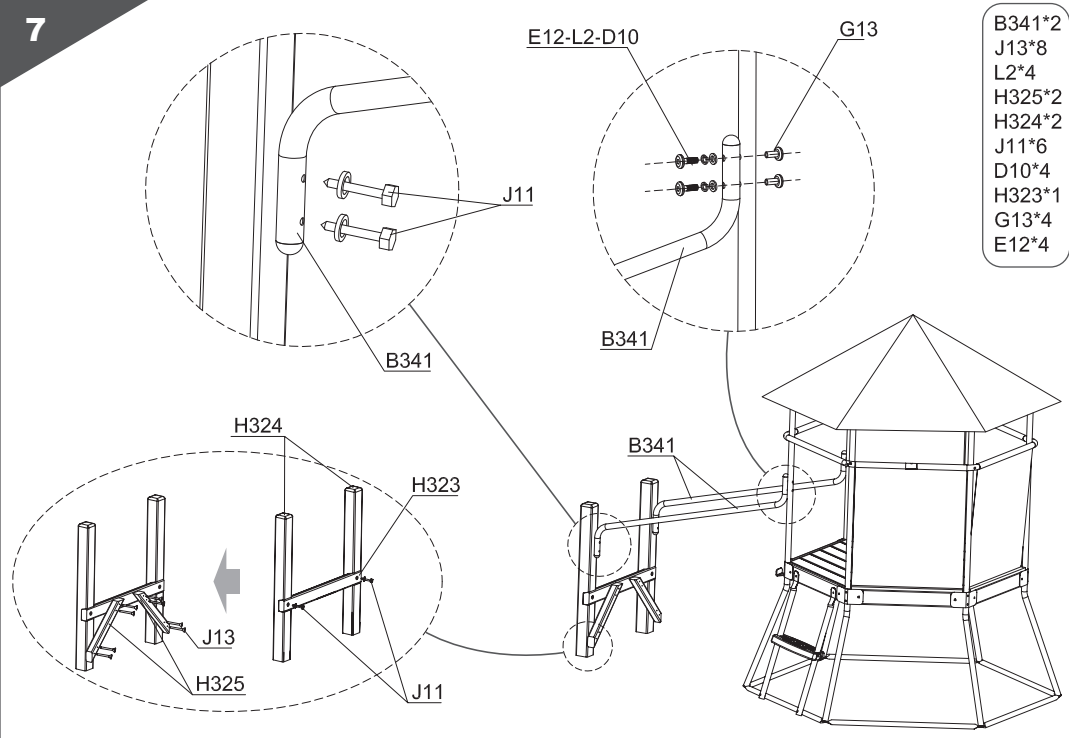

- B341\*2
- J13\*8
- L2\*4
- H325\*2
- H324\*2
- J11\*6
- D10\*4
- H323\*1
- G13\*4
- E12\*4



8

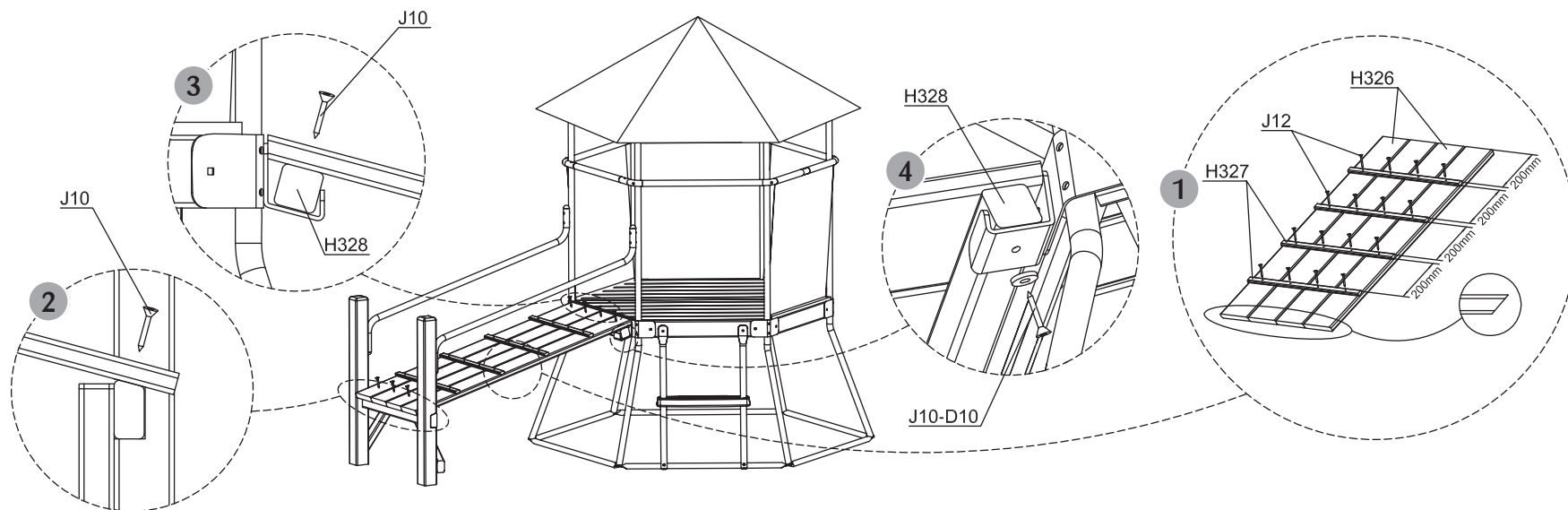

- H326\*4
- H327\*4
- H328\*1
- J12\*16
- J10\*10
- D10\*2

9

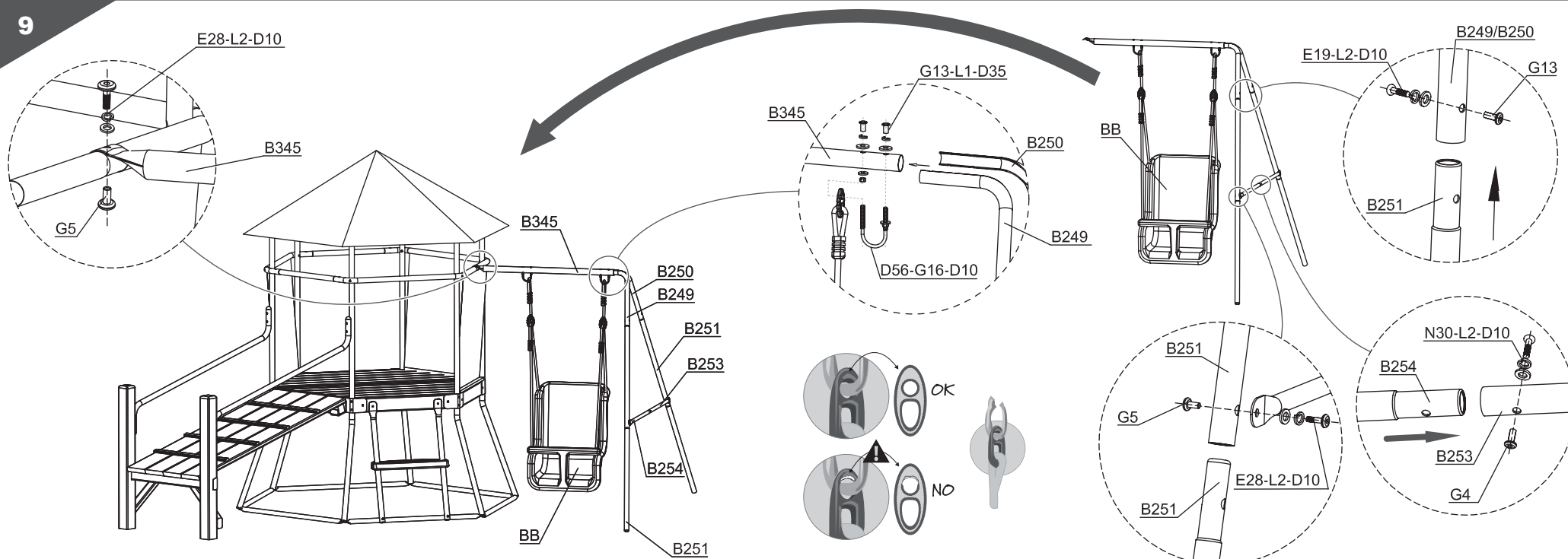

- B345\*1
- B254\*1
- G13\*6
- D10\*10
- B250\*1
- D56\*2
- E19\*2
- L1\*4
- B249\*1
- G16\*4
- E28\*3
- D35\*4
- B251\*4
- BB\*1
- L2\*6
- N30\*1
- B253\*1
- G5\*3
- G4\*1





10

C17\*1  
J3\*2

11

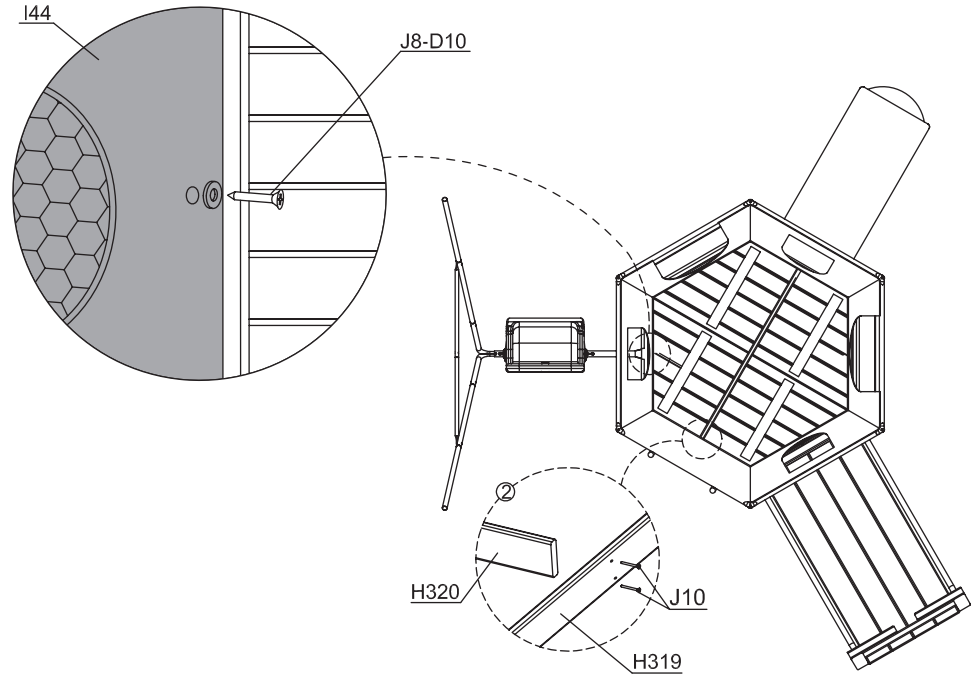

I44\*1  
D15\*6  
L2\*2  
J10\*4  
J18\*2  
G5\*2  
D10\*8  
J8\*6  
D2\*4  
E28\*2  
H320\*1

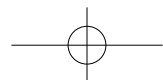
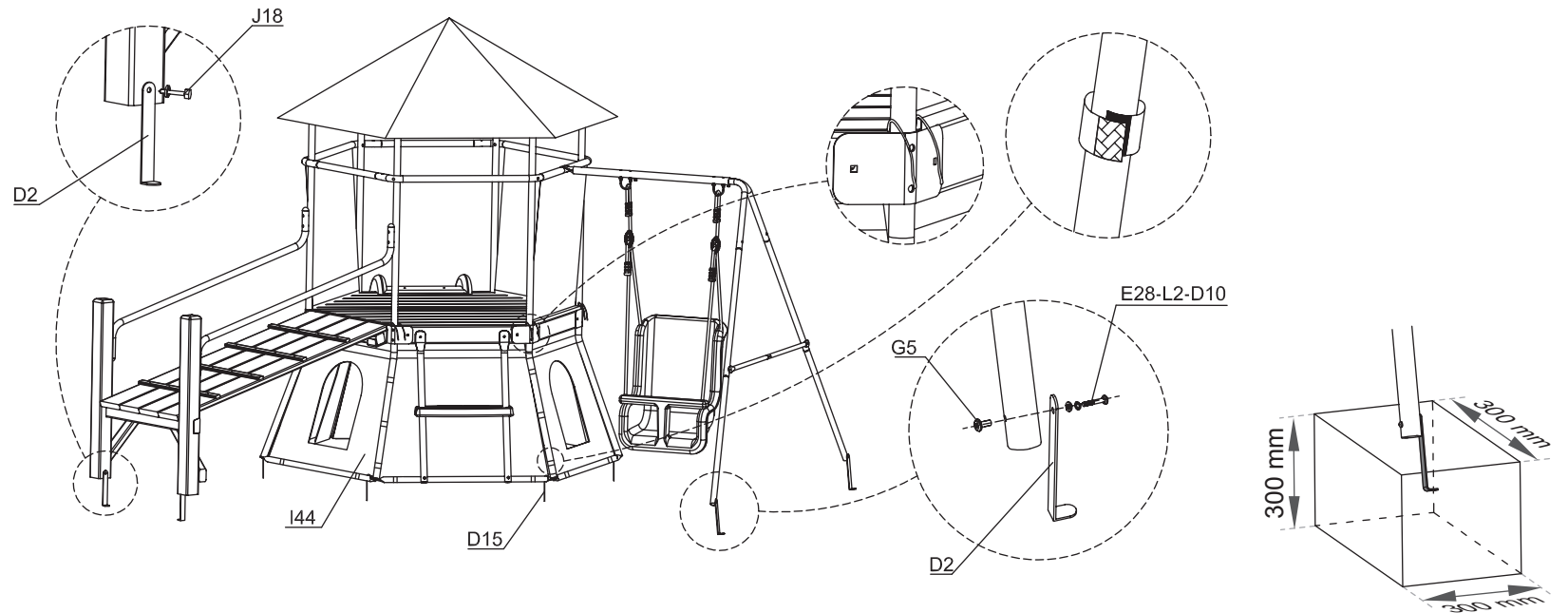

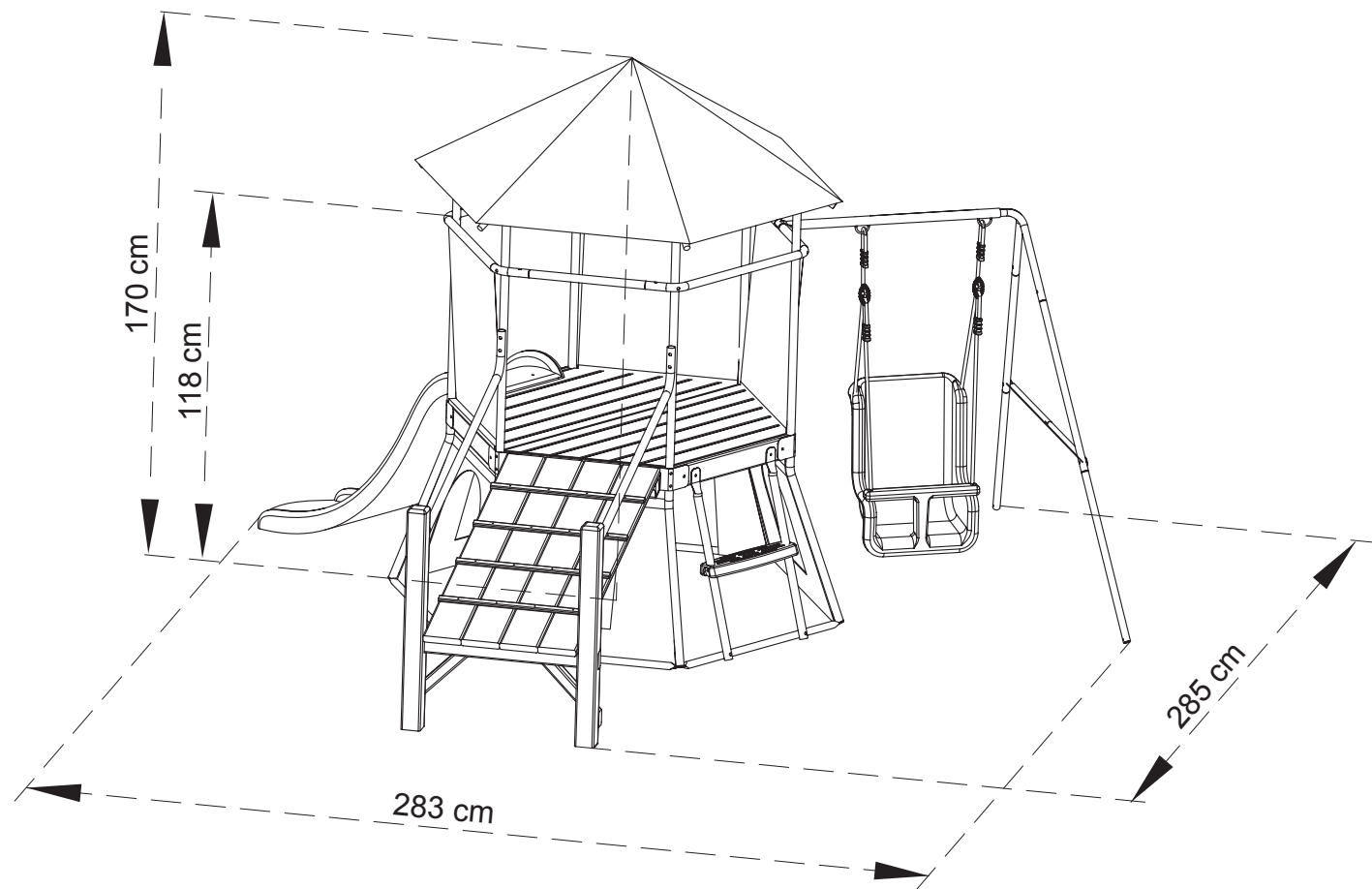
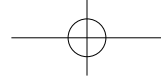

**Warning: Maximum fall heights 118 cm**

