

Millenium Included parts

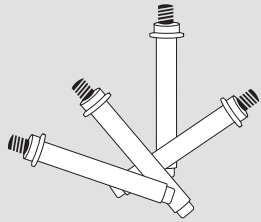

4 DYNA BOLT

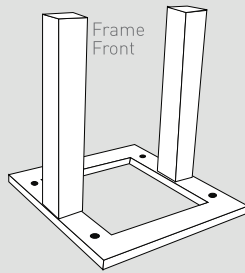

1 BASE FRAME

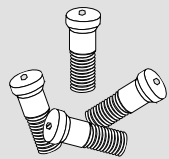
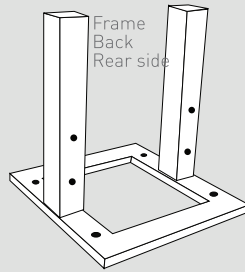

4 SCREWS

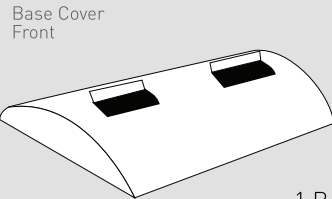

1 BASE COVER

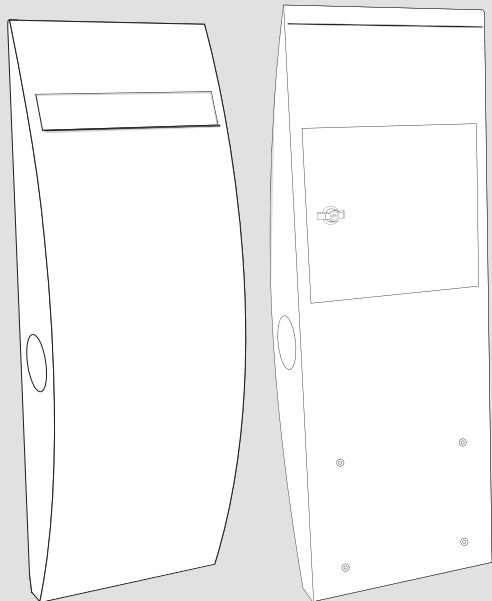
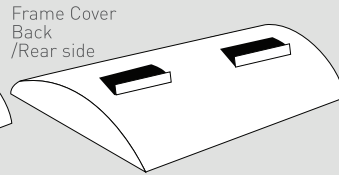

Body Front

1 BODY

Body Back

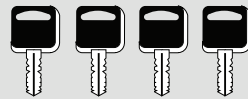

4 KEYS



1 ALLEN KEY

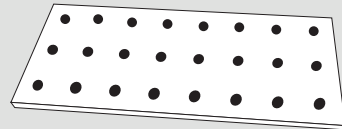

1 DRIP TRAY

It is recommended to fix the Millenium pillar mail box to a concrete base (or similar)

Options for your base

1. Concrete pad base

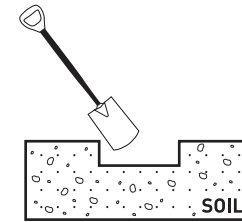

Dig a hole for the size of Concrete pad

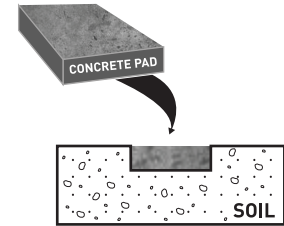

Seat concrete pad level

2. Building your own base

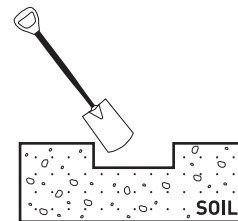

Dig a hole

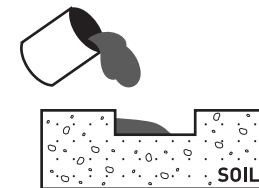

Pour mixed quick set concrete

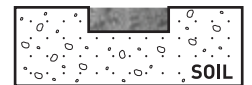

Allow to set

How to install Pillar Mail box

Step 1
Place base frame in desired location.
Make sure that it is level, to ensure mailbox will be straight.

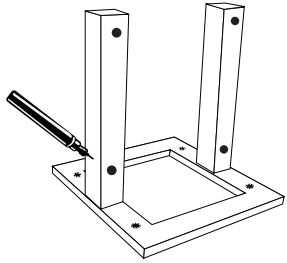

Step 2
Using a pencil mark out the 4 holes of the base frame onto the concrete.

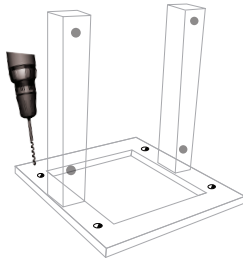

Step 3
Take base frame away and pre-drill holes using a 12 mm masonry drill bit.

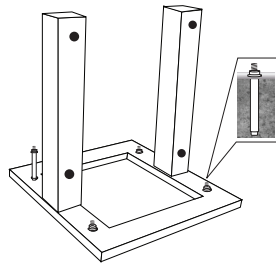

Step 4
Position base frame, insert the dynabolts into the 4 holes and secure by tightening. Holes on the upright of the frame should be on the rear side.

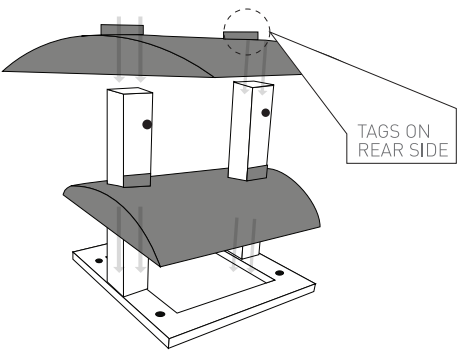

Step 5
Place base cover over frame.

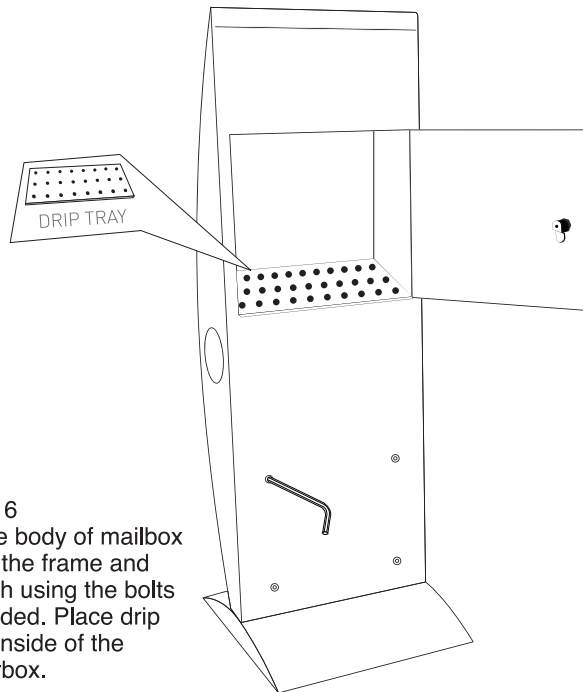

Step 6
Place body of mailbox onto the frame and attach using the bolts provided. Place drip tray inside of the letterbox.

Millenium Pillar Mailbox Instructions

