

PILLAR
LETTERBOX

INSTRUCTION

BERTA THICK GAUGE MILD STEEL PILLAR	BUZFP01
CESAR TIMBER PANEL FRAME WITH STAINLESS STEEL WALL BOX	BUZFP02
RUBEN STAINLESS CURVED FRONT PILLAR	BUZFP03
HUGO STAINLESS PILLAR WITH TIMBER	BUZFP04



BERTA



CESAR



RUBEN



HUGO

BERTA

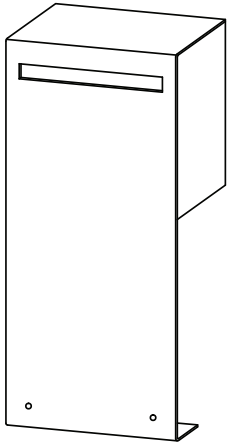

LETTERBOX
BODY

CESAR

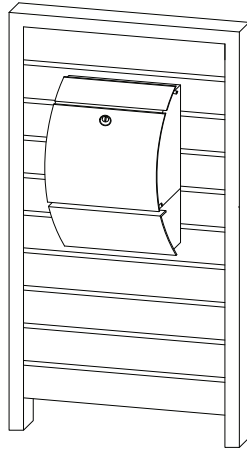

LETTERBOX
BODY



SCREW X 4



WASHER X 4

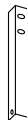

MOUNTING
ANCHORS X 4

RUBEN

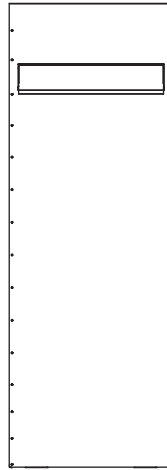

LETTERBOX
BODY

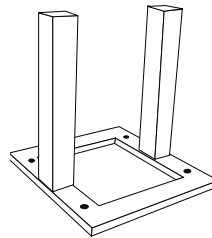

FRAME

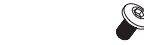

SCREW X 4



DYNABOLT X 4

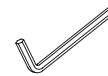

ALLEN KEY

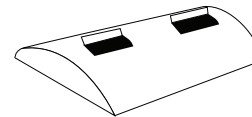

FRAME COVER

HUGO

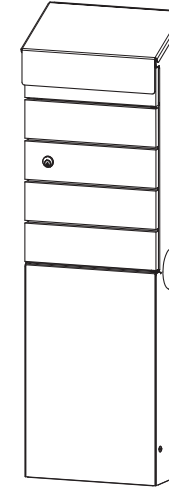

LETTERBOX
BODY



SCREW X 4



DYNABOLT X 4

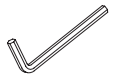

ALLEN KEY

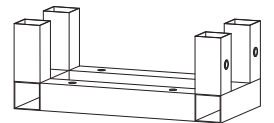

FRAME

INCLUDED PARTS

Preparing your base for ruben and Hugo

Option for your base

1. Using concrete pad

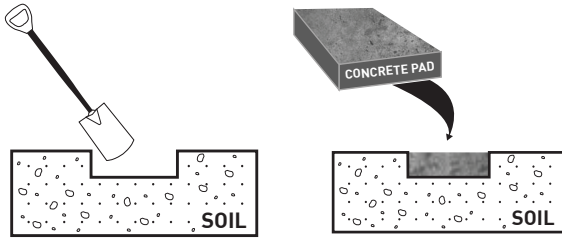

Dig a hole for the size of Concrete pad

* Cesar: Dig 2 holes to suit the vertical posts.

Seat concrete pad level

2. Pouring your own concrete base

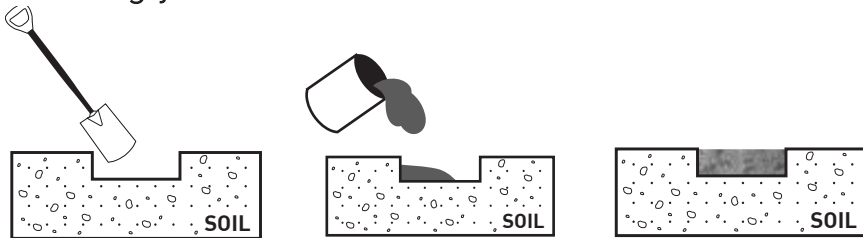

Dig a hole

* Cesar: Dig 2 holes to suit the vertical posts.

Pour mixed quick set concrete

Allow to set

RUBEN

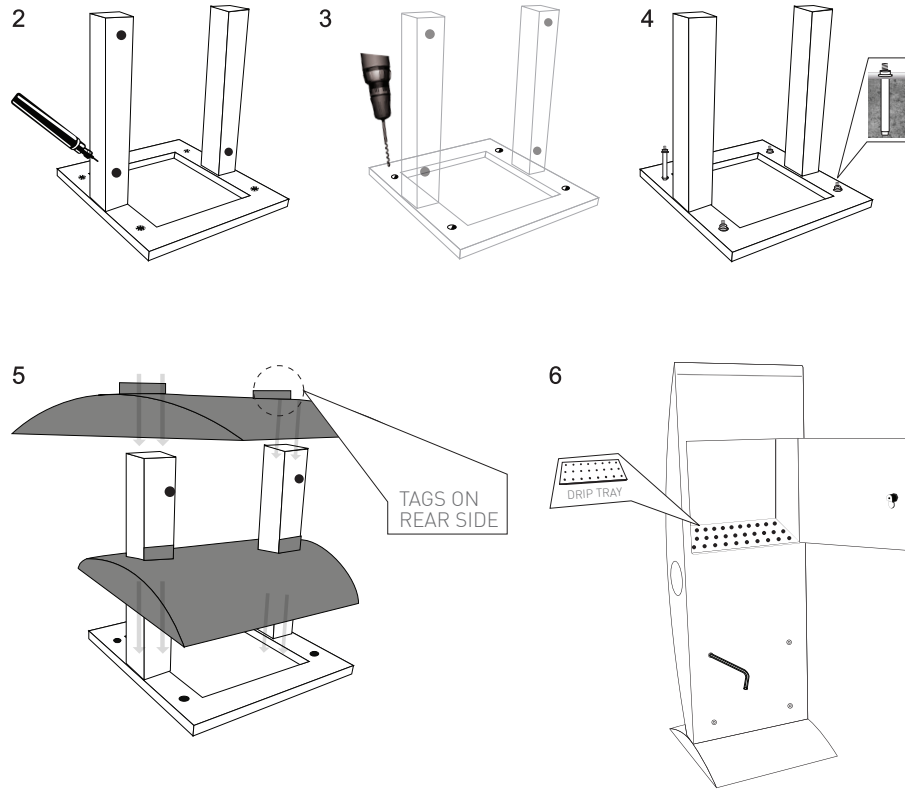

STEP 1
Place base frame in desired location. Make sure that it is level, to ensure mailbox will be straight.

STEP 2
Using a pencil mark out the 4 holes of the base frame onto the concrete.

STEP 3
Take base frame away and pre-drill holes using a 12 mm masonry drill bit.

STEP 4
Position base frame, insert the dynabolts into the 4 holes and secure by tightening. Holes on the upright of the frame should be on the rear side.

STEP 5
Place base cover over frame.

STEP 6
Place body of mailbox onto the frame and attach using the bolts provided. Place drip tray inside of the letterbox.

HUGO

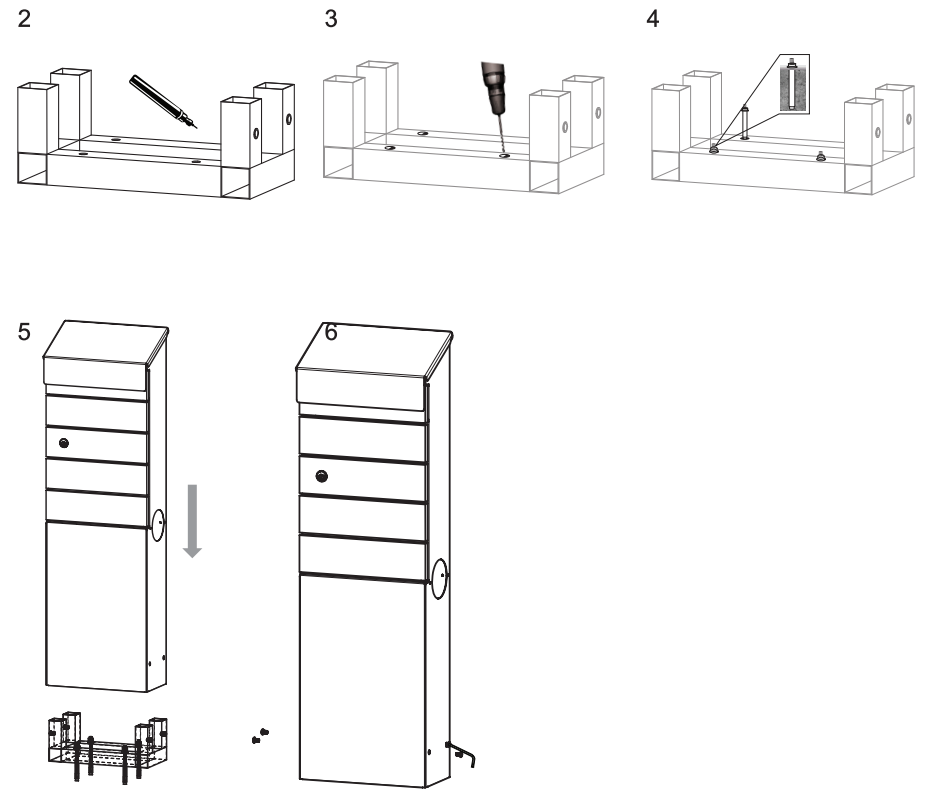

STEP 1
Place base frame in desired location. Make sure that it is level, to ensure mailbox will be straight.

STEP 2
Using a pencil mark out the 4 holes of the base frame onto the concrete.

STEP 3
Take base frame away and pre-drill holes using a 12 mm masonry drill bit.

STEP 4
Position base frame, insert the dynabolts into the 4 holes and secure by tightening.

STEP 5
Place letterbox body over frame.

STEP 6
Attach using the bolts provided.

CESAR

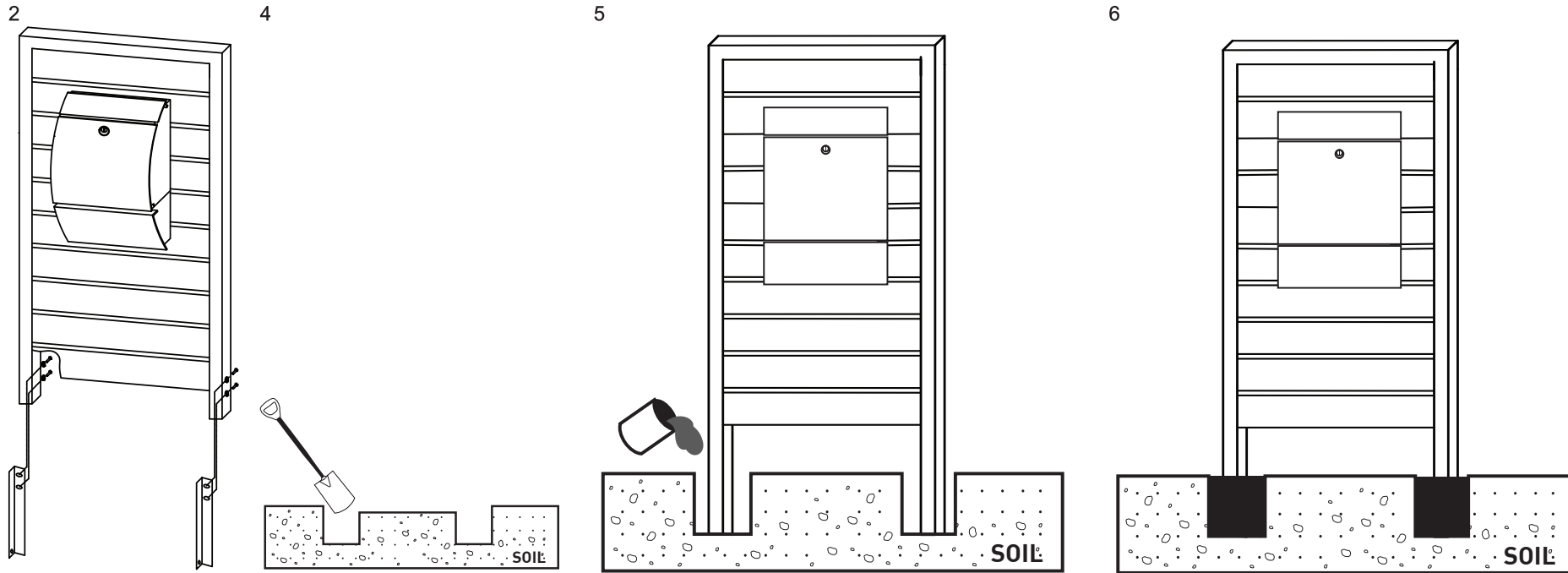

STEP 1
Choose an appropriate place to mount your mailbox.

STEP 2
The mounting anchors are screwed into the bottom of the legs. Unscrew these and refix them so that they extend from the bottom of the steel legs.

STEP 3
Hold the frame in place and mark the ground where you will need to dig holes.

STEP 4
Dig 2 holes to suit the vertical posts.

STEP 5
Place the frame into the ground and pour ready mix concrete into the 2 holes.

STEP 6
Level the frame and Allow the concrete to set.

BERTA

1

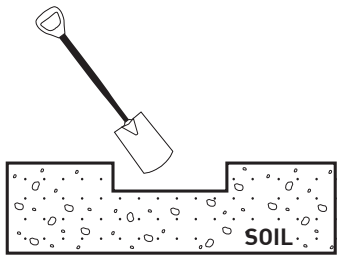

2

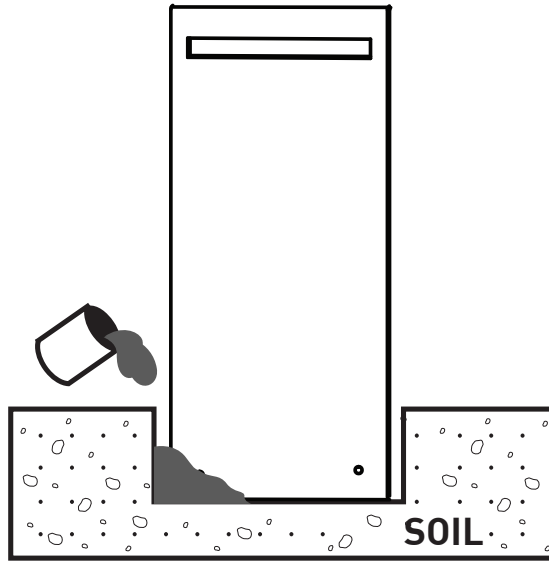

3

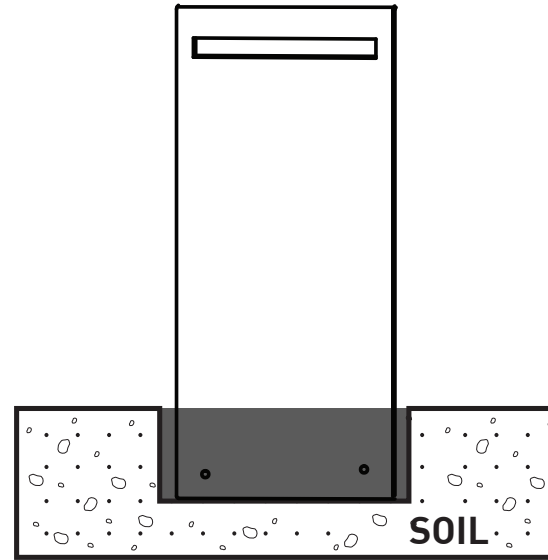

STEP 1
Find desired location of letterbox and dig hole to suit face size a minimum of 200mm deep.

STEP 2
Place letterbox into hole and fill with rapid set concrete.

STEP 3
Using a spirit level, ensure that letterbox is level on all sides while concrete sets.