



## 8 GUNSAFE INSTRUCTIONS

Serial No.

Key No.

**!** *Do not store access keys or instructions  
inside your safe!*

## INSTALLING YOUR SAFE

For installation into concrete surfaces use masonry bolts provided.

1. Install your safe in a location that is secure and sturdy.
2. Drill holes for masonry bolts in the desired location.
3. Insert the masonry bolts through the holes in the safe and into the concrete.
4. Tighten masonry bolts using the allen key provided.

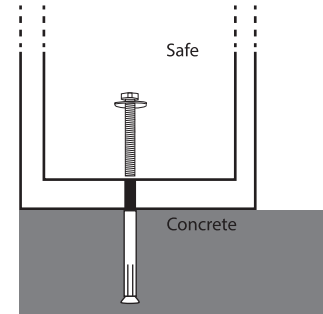

For installation into timber surfaces use coach screws provided.

1. Install your safe in a location that is secure and sturdy.
2. Pre-drill holes in the desired location.
3. Insert the coach screws through the holes in the safe and into the timber.
4. Tighten coach screws using a socket or spanner.

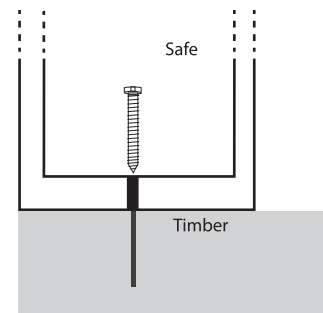

All safes should be bolted down to ensure the best possible security.

## OTHER NOTES

- If you wish to clean your safe, use a damp cloth. Do not use liquid or sprayers.
- Never try to dismantle the product by yourself.
- Safe must be installed in an upright position or the warranty shall be void.
- Keep this record of your key number in a secure place, not inside the safe.

A safe is an aid only in reducing theft, it must form only a part of a range of security measures used. Sandleford Holdings will not accept or be held responsible for any loss or damage caused in the event of theft or unauthorised use.

Ph (03)9786 0055