

Customer Support: (03) 9786 0055

### Shangri La Multi Play Cubby(MCH117)

Thank you for purchasing the Shangri La Multi Play Cubby(MCH117)  
Warning: Only for domestic outdoor use.

This play cubby satisfies all the requirements of the Australian Standard AS/NZS ISO 8124 and has been certified by an independent laboratory. To guarantee safety, please give special attention to the assembly, safety, and care instructions detailed in this document.

#### ASSEMBLY ADVICE

- Follow the instructions exactly.
- This product must be assembled by adults.
- Once assembly has been completed, keep the instructions in a safe place for future reference. This can be particularly handy for identification of parts if any after sales service is required.
- Before commencing assembly, check that none of the parts are missing. If you find that you are missing a part please contact our after sales service department.
- Retain extra parts to use as spares in the future if necessary.
- Pre-Drill timber before fixing with screws to avoid cracks in the timber.

The dimensions given in the instructions are indicative only, they may vary according to the assembly method.

#### SAFETY ADVICE

- Warning: This product is only to be used by children between the ages of 3 and 7.
- Warning: Not to be used by anyone weighing over 45kgs. simultaneously, not to exceed a combined weight of 135kgs.
- Warning: Choking hazard-small parts can be dangerous for children .
- Warning: This play set must be used under adult supervision.
- This product is for private use at home only. Under no circumstances is it to be used in parks, schools, camp sites, hotels, public leisure areas etc.
- The Cubby Play Set should be set up on a flat surface and 2 metres away from any structures or obstacles (walls, fences, trees, washing lines, cables etc).
- To avoid eye damage, we advise that the slide should not be setup directly facing the sun.
- The Play Set should be installed over impact absorbing surfaces such as sand, wood-bark chips, rubber and foam and must NOT be set up on a hard surface (concrete, tarmac etc). For detailed information about surfaces please refer to the attached consumer information sheet.
- We recommend to secure your Play Set firmly into the ground using cement
- Please note this is a natural product and as such should be checked for any rough surfaces before use, if required these should be lightly sanded in order to prevent injury.
- The anchorage must be checked regularly.
- Dispose of packaging thoughtfully.
- Do not allow children to play with packaging.
- Please see below diagram for maximum fall height of swing.

CAUTION ! This Product includes timber and/or fabric, Please Keep away from fire.

#### FIXING INTO THE GROUND

IMPORTANT ! For safety reasons, your cubby must be embedded into the ground.

- Place your cubby in the desired position and mark a square area 350mm x 350 mm around each of the feet. Dig holes 350 mm deep. (The feet must be in the center of the square)
- Fill the holes with concrete. Do not exceed the ground level. Fit the embedding piece into the center of the concrete so that fixtures for screwing the posts into place rise out of the concrete.
- When the concrete is dry, screw the posts to the embedding pieces.
- Anchors shall be placed level with or under ground in order to reduce tripping hazards.

IMPORTANT ! Wait until the concrete is set before using and check anchorages regularly.

#### MAINTENANCE

- All parts should be checked at least once a month.
- Check all nuts and bolts for tightness and tighten when required.
- Check for signs of wear to bolt coverings. If sharp edges are found, replace as required.
- In certain regions (seaside areas), certain coatings could be prone to damage. In this case, it is advised to use a rust prevention treatment.
- The ground on which the play centre is set up should be cleared regularly. All objects such as stones or anything else that could cause injury in the case of a fall should be removed.
- It is recommended that during the winter period when the equipment is not in use, all apparatus are removed to prevent deterioration due to bad weather.
- Modifications to the original activity toy should only be carried out under instructions from the manufacturer.
- Defective parts should only be replaced in accordance with the manufacturer's instructions
- sand rusted areas and tubular members and repaint using a non-lead based paint when required.
- As timber is a natural product, It will deteriorate in the weather over time. For maximum longevity of your timber, it is highly recommended to apply an initial 3 coats of a timber protectant such as an exterior grade oil before first use of the play set.

All outdoor wooden products require routine inspection and regular maintenance. After installation, a follow-up inspection should take place after one week and twice a month thereafter for the remaining life of your play products. Maintenance should be performed at any time it is deemed necessary. As a general rule, major maintenance (wood refinishing) should be performed at twelve month intervals from the date of installation. Inspect and perform maintenance based on the following checklist.





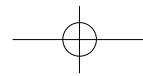

Major wooden parts: Inspect for splintering and structure defects at regular intervals. For very minor splinters or chipping, lightly sanding and refinish with an exterior water repellent stain can assist. If timber has cracked or split significantly, replacement parts may be required, please contact national customer service centre for any replacement requirements

At regular intervals, the application of a penetrating oil based sealer stain to all wooden components is essential. Please consult your local hardware or home improvement store for recommendation of an appropriate product. Ensure the product does not contain hazardous chemicals on a dry that can pose a potential health risk to children.

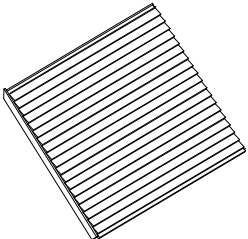
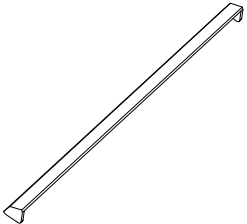
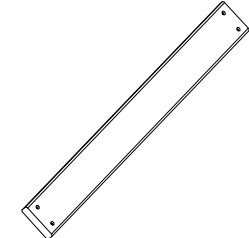
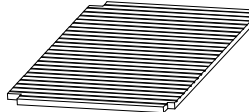
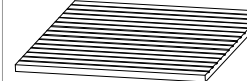
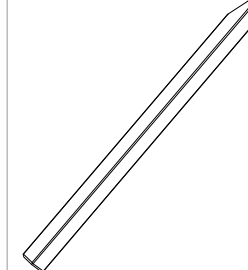
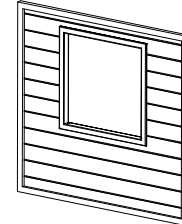
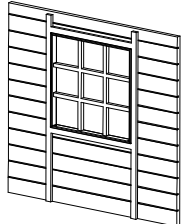
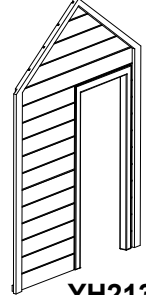
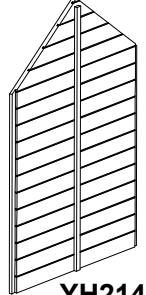
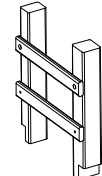
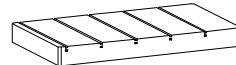
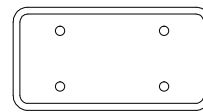
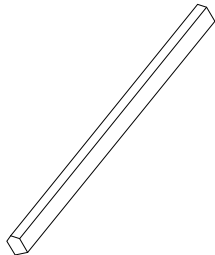
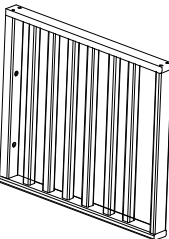
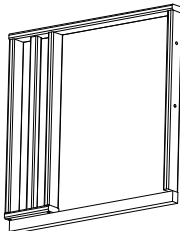
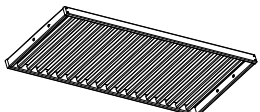
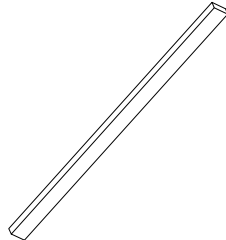
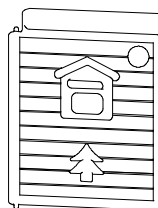
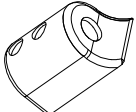
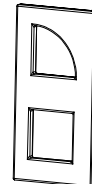



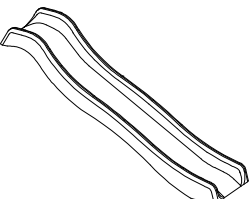
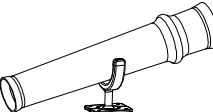
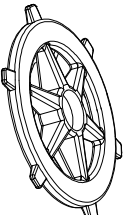



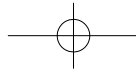

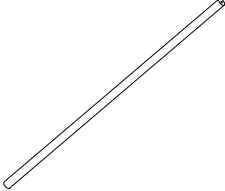
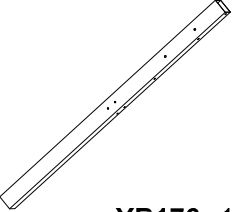
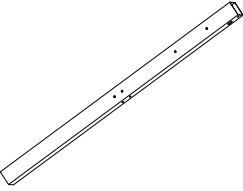
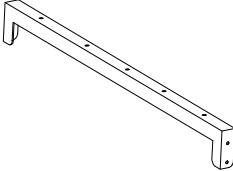
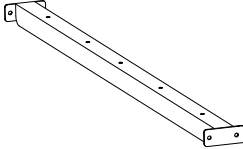
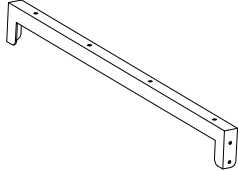
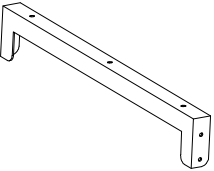
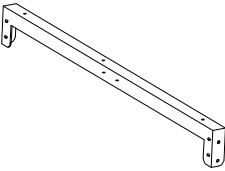
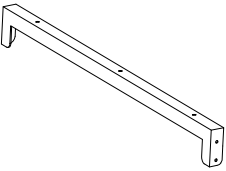





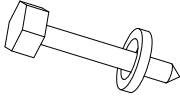
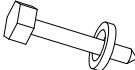





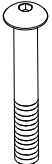

We hope you have a safe and enjoyable time using the Cubby Play Set.



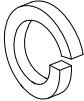
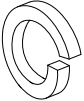

 <b>YH19 x2</b>	 <b>YH20 x1</b>	 <b>YH118 x6</b>	 <b>YH205 x1</b>	 <b>YH206 x1</b>	 <b>YH210 x2</b>	 <b>YH211 x1</b>
 <b>YH212 x1</b>	 <b>YH213 x1</b>	 <b>YH214 x1</b>	 <b>YH216 x2</b>	 <b>YH217 x1</b>	 <b>YH218 x1</b>	 <b>YH219 x1</b>
 <b>YH305 x1</b>	 <b>YH306 x1</b>	 <b>YH307 x1</b>	 <b>YH308 x1</b>	 <b>YC6 x1</b>	 <b>YC7 x2</b>	 <b>YC15 x2</b>
 <b>YC16 x3</b>	 <b>YC20 x1</b>	 <b>YC23 x2</b>	 <b>YC24 x1</b>	 <b>YC31 x1</b>	 <b>YC32 x1</b>	 <b>YC33 x6</b>

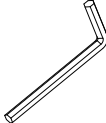
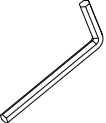

 <b>YB76</b> x4	 <b>YB175</b> x1	 <b>YB176</b> x1	 <b>YB274</b> x2	 <b>YB275</b> x1	 <b>YB276</b> x1	 <b>YB277</b> x2		
 <b>YB278</b> x1	 <b>YB279</b> x2	 <b>YB280</b> x2	$\text{Ø}4.5 \times 40$  <b>YJ1</b> x24	$\text{Ø}5 \times 25$  <b>YJ3</b> 37	$\text{Ø}4.5 \times 45$  <b>YJ4</b> x30	$\text{Ø}4.5 \times 20$  <b>YJ8</b> x3		
$\text{Ø}4.5 \times 35$  <b>YJ10</b> x48	$\text{Ø}6 \times 50$  <b>YU1</b> x2	$\text{Ø}6 \times 40$  <b>YJ18</b> x2	$\text{Ø}6 \times 74$  <b>YE13</b> x24	$\text{Ø}6 \times 80$  <b>YE14</b> x4	$\text{Ø}6 \times 95$  <b>YE17</b> x4	$\text{Ø}6 \times 13$  <b>YE19</b> x6		
$\text{Ø}8 \times 30$  <b>YE26</b> x12	$\text{Ø}8 \times 50$  <b>YE27</b> x1	$\text{Ø}6 \times 105$  <b>YE44</b> x4	$\text{Ø}6 \times 12$  <b>YG5</b> x4	 <b>YG8</b> x12	$\text{Ø}8$  <b>YG9</b> x1	$\text{Ø}6 \times 20$  <b>YG13</b> x36		
$\text{Ø}8$  <b>L1</b> x20	$\text{Ø}6$  <b>L2</b> x38	$\text{Ø}6$  <b>YD10</b> x38	$\text{Ø}8$  <b>YD11</b> x8	$\text{Ø}8$  <b>YD35</b> x12	 <b>YD16</b> x2	 <b>A4</b> x2	 <b>A5</b> x1	 <b>A6</b> x1

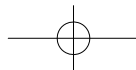

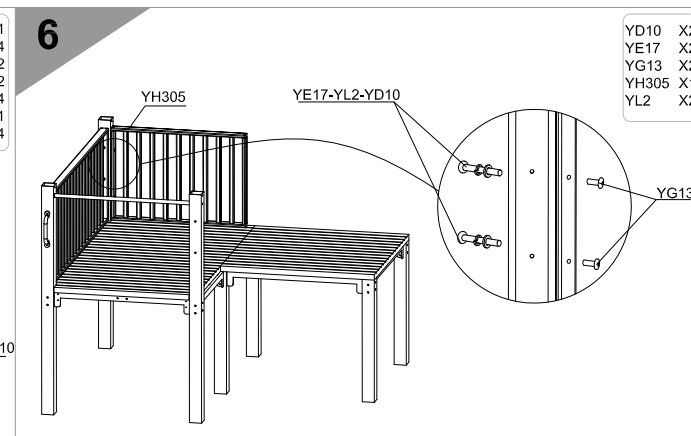
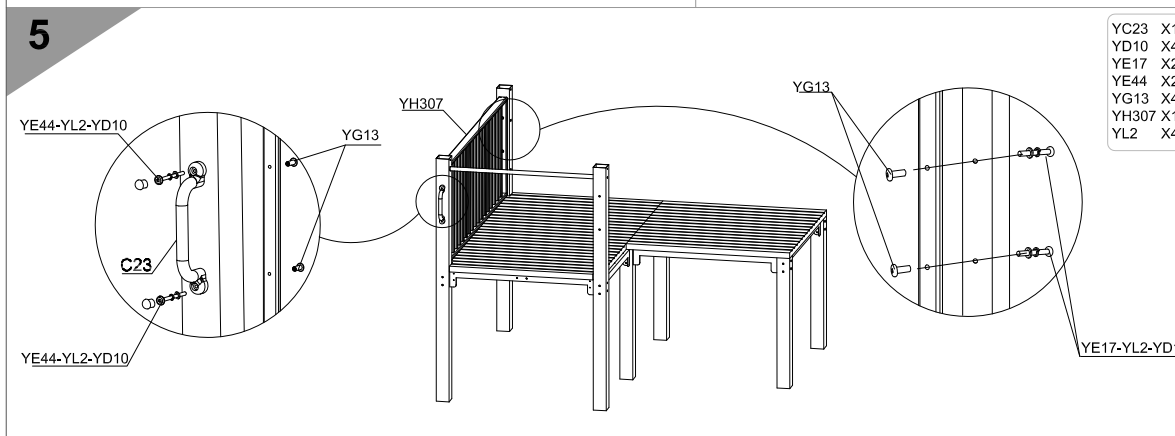
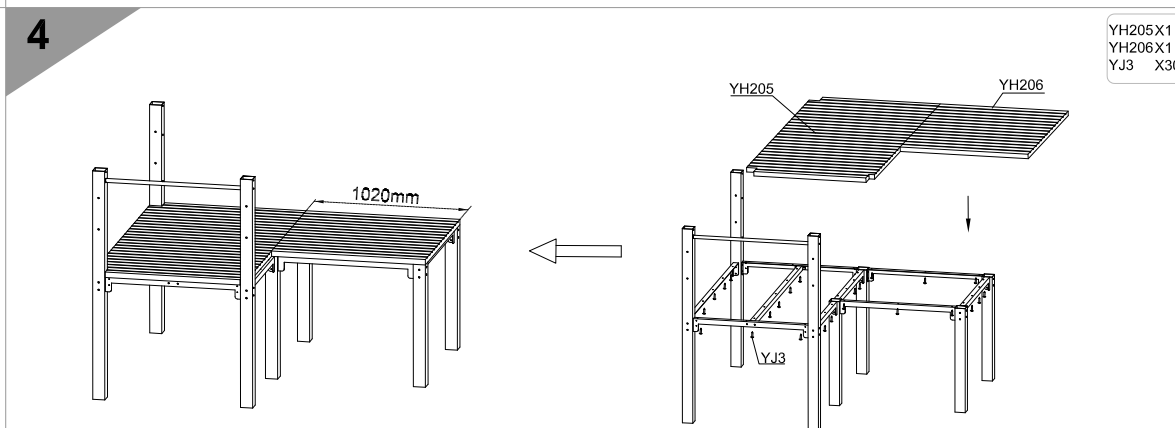
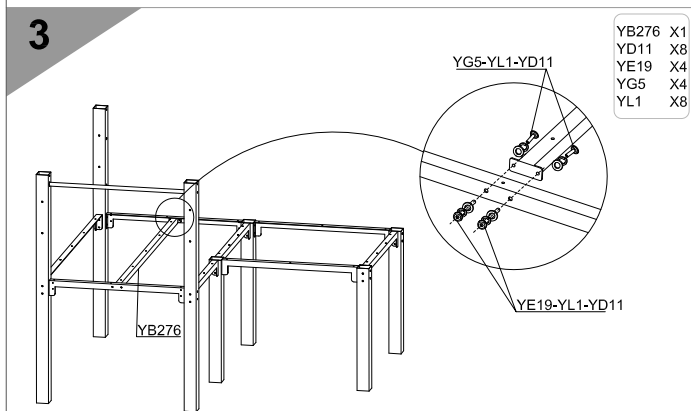
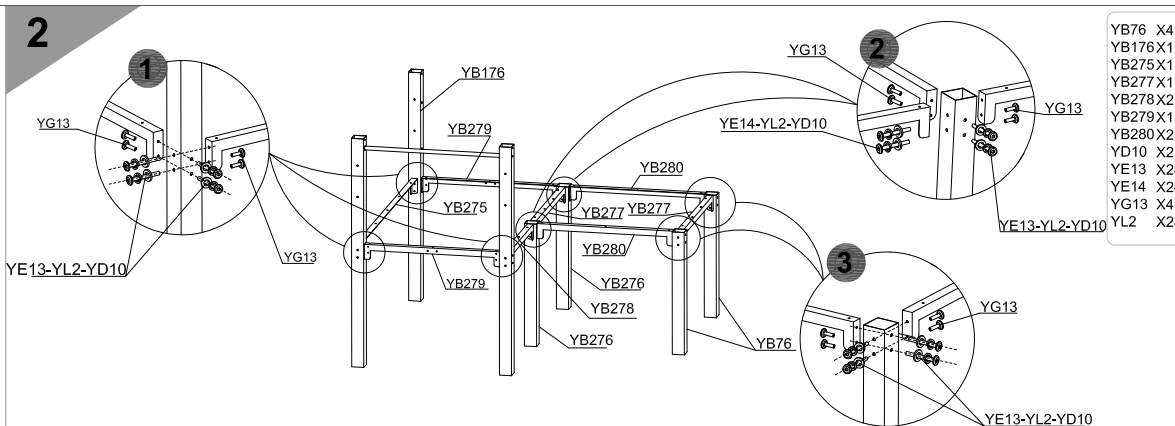
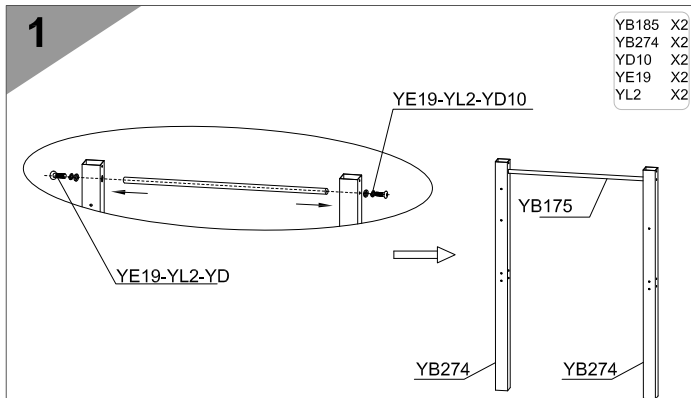
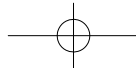

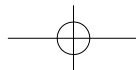
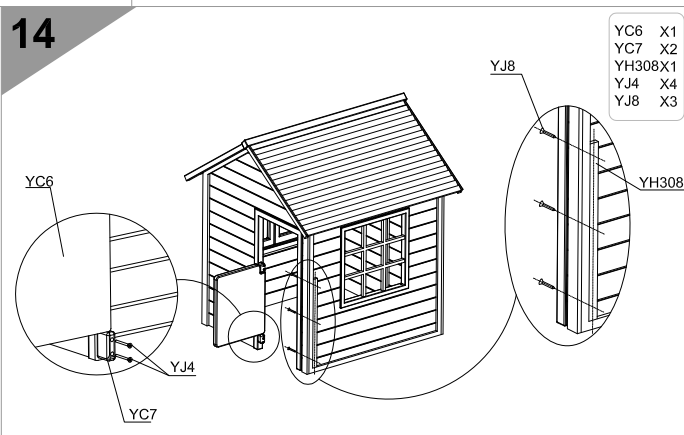
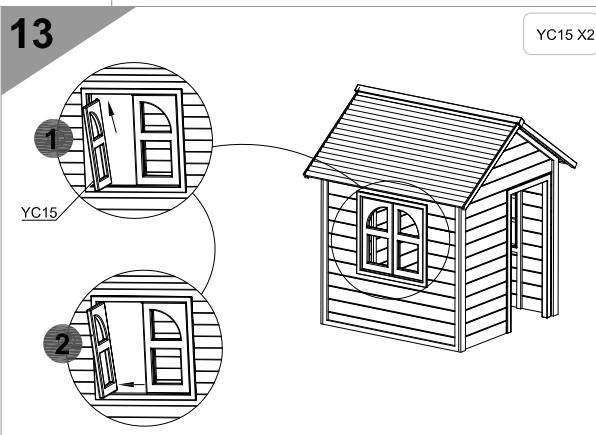
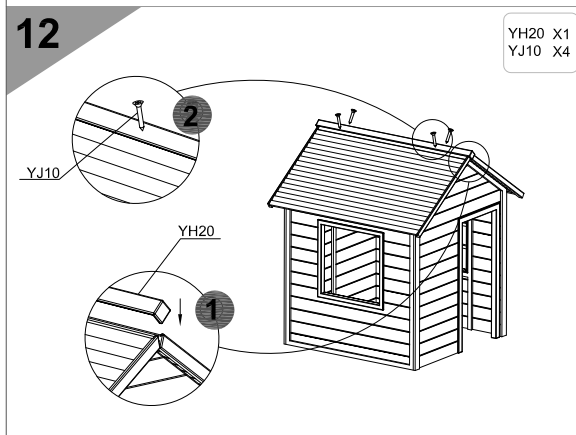
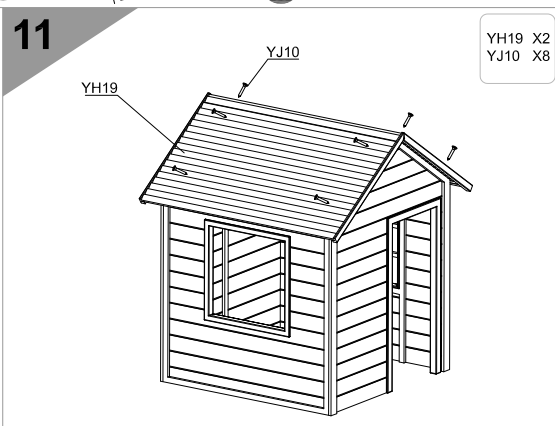
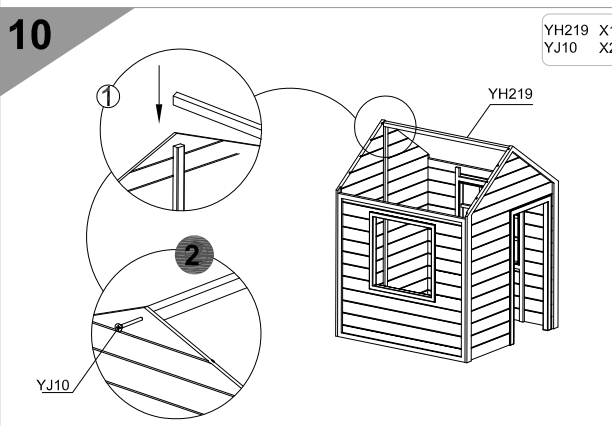
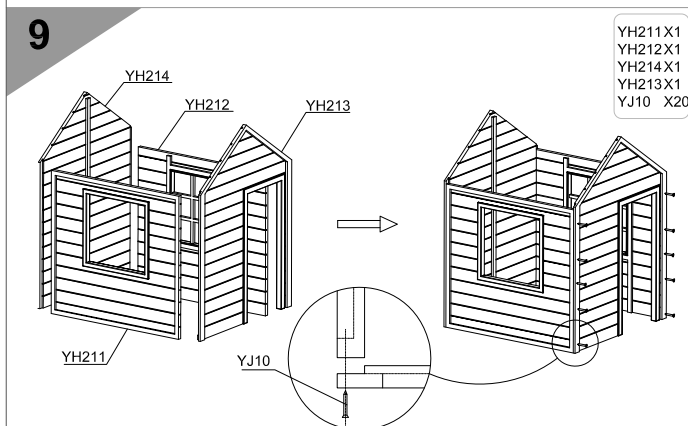
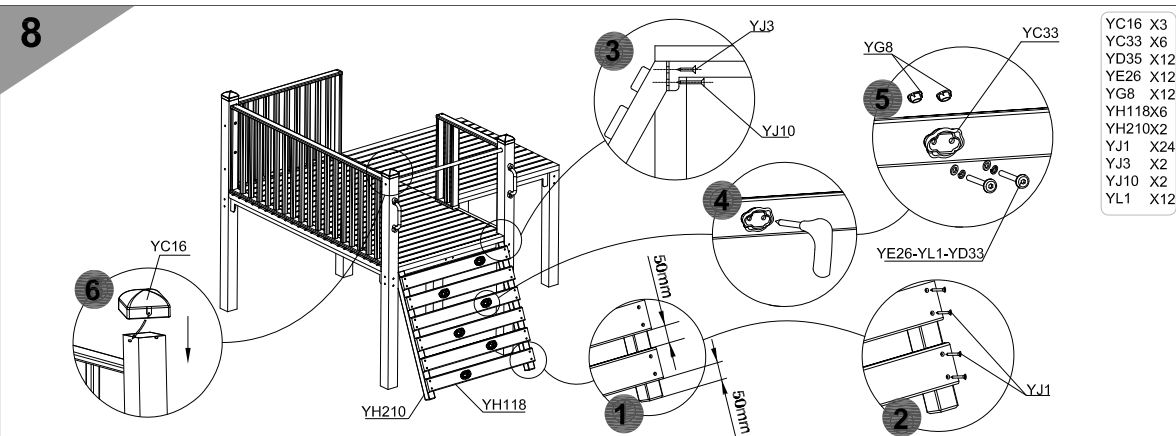
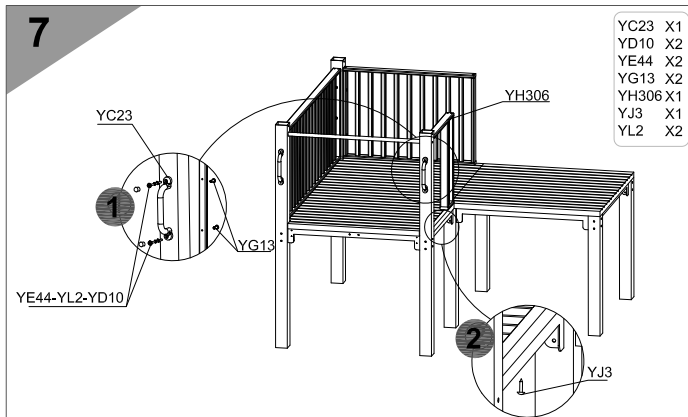
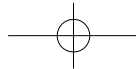

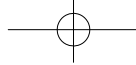

15

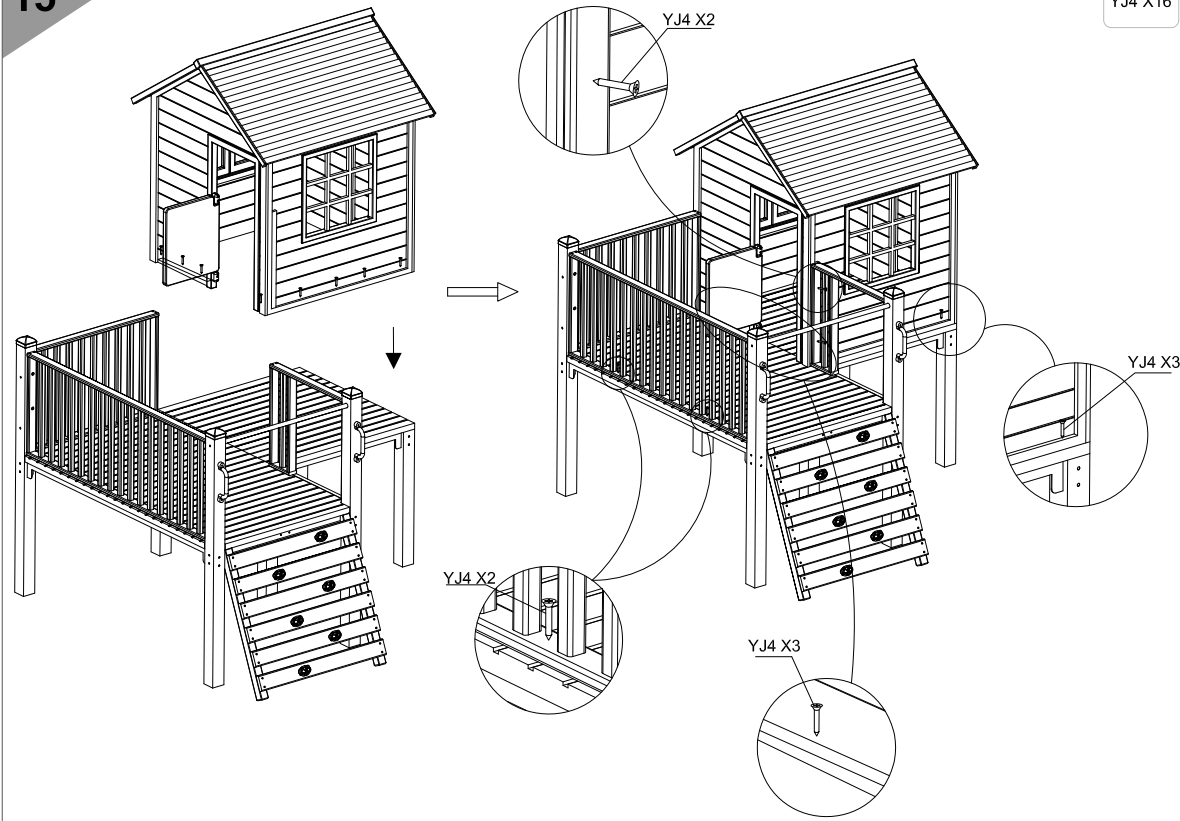

YJ4 X16

16

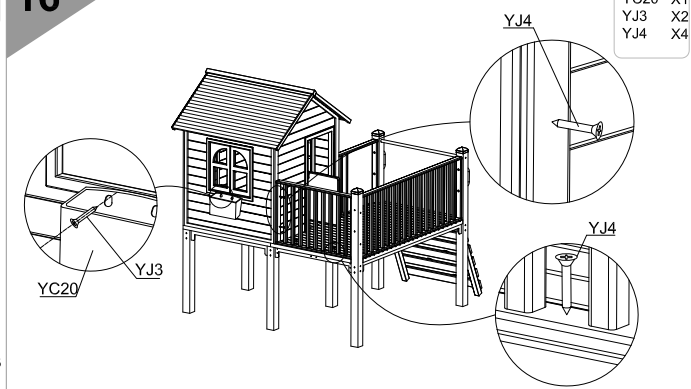

YC20	X1
YJ3	X2
YJ4	X4

17

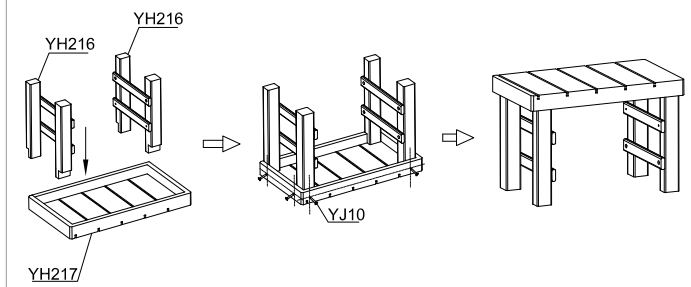

YH216	X2
YH217	X1
YJ10	X8

18

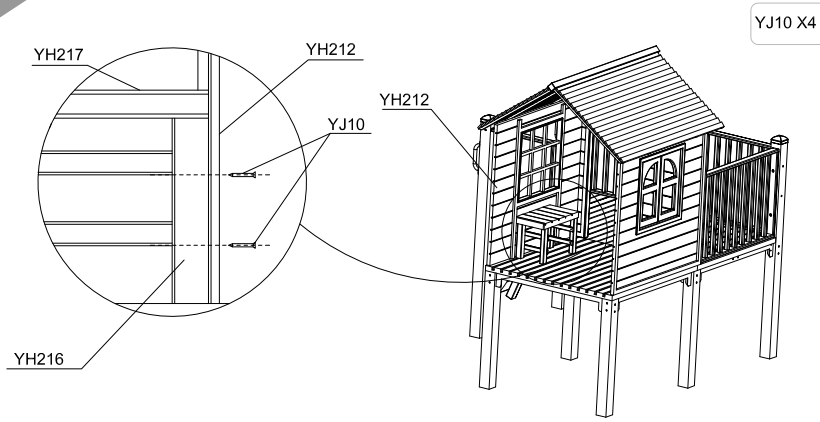

YJ10 X4

19

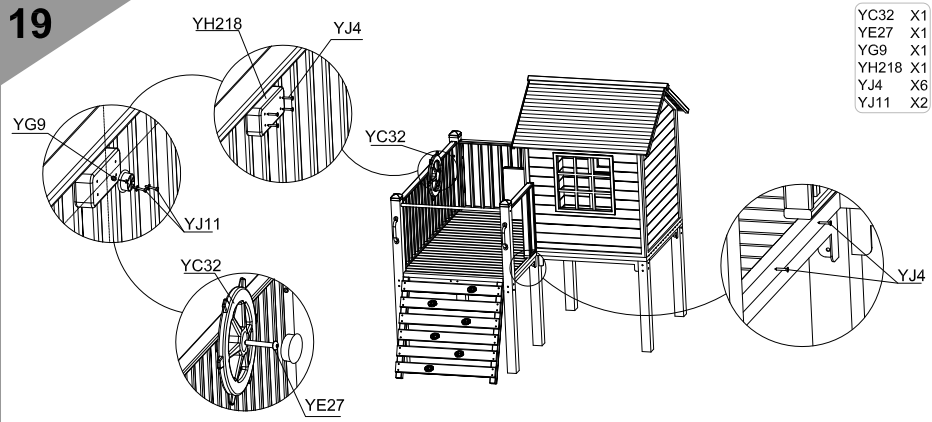

YC32	X1
YE27	X1
YG9	X1
YH218	X1
YJ4	X6
YJ11	X2

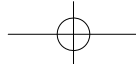

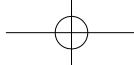

20

YC24 X1  
YC31 X1  
YJ3 X2

21

YJ18 X2  
YD16 X2

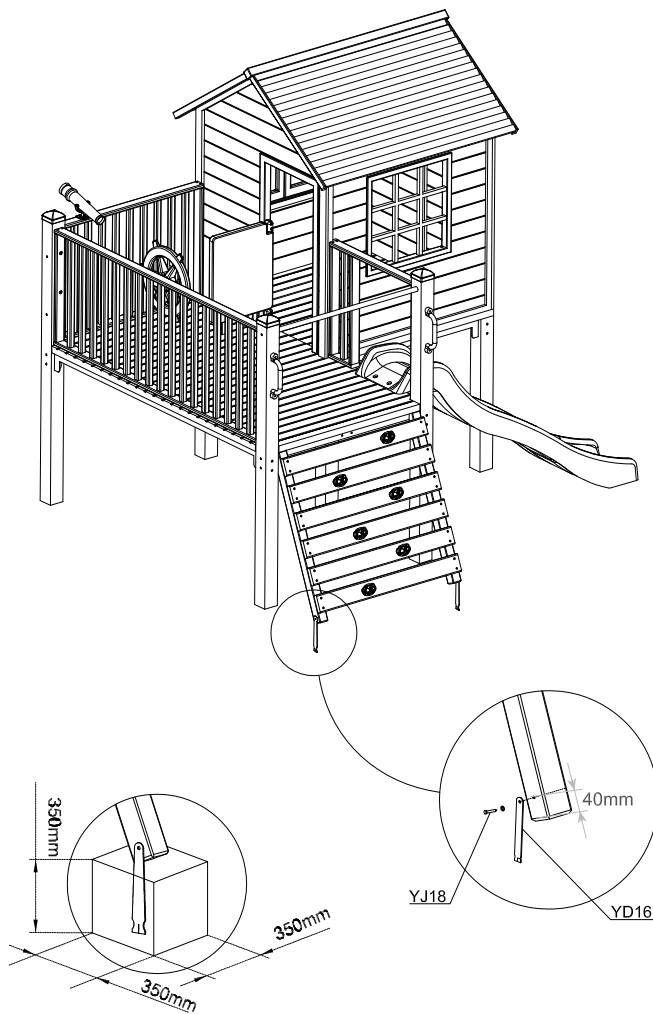
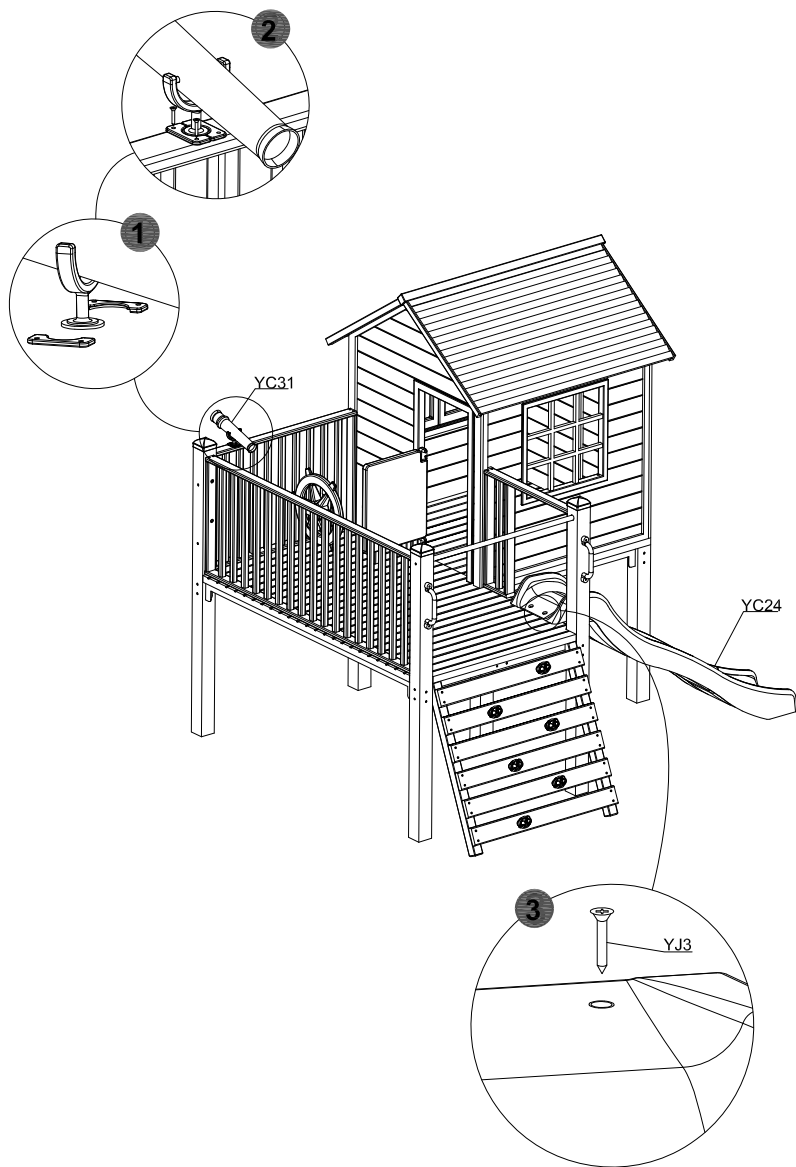

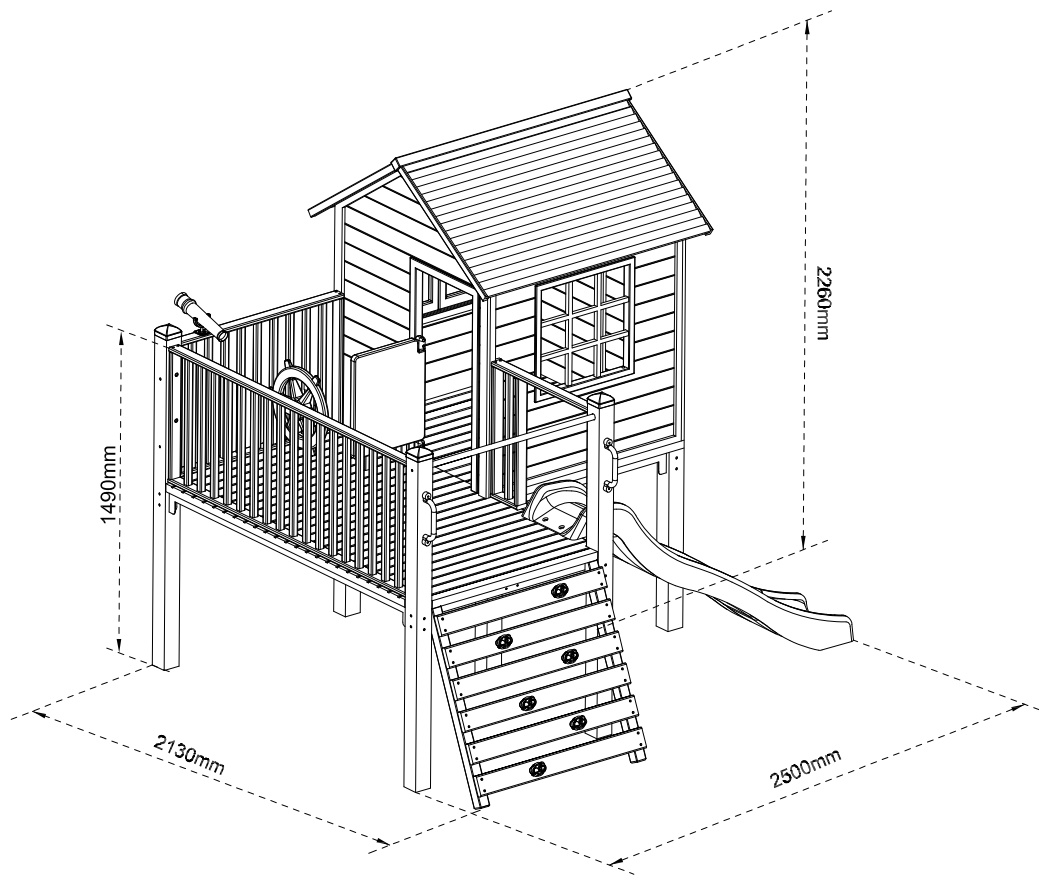
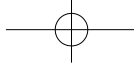

**Warning: Maximum fall heights 149 cm**